

Linear DC Motors

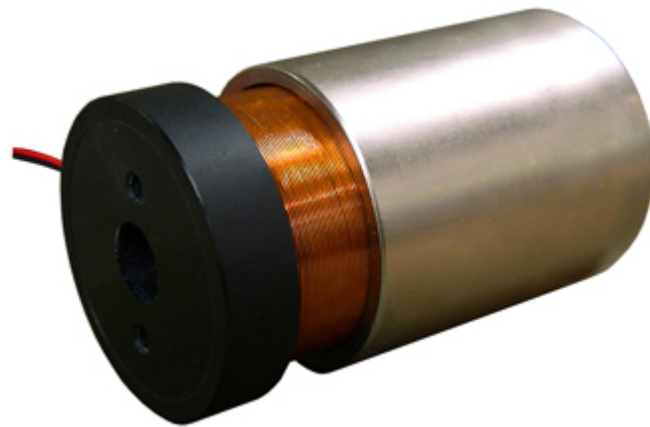







motiCONT

Moticont
6901 Woodley Avenue
Van Nuys, California 91406 U.S.A.
www.moticont.com

Toll Free (888) 785-1804
+1 (818) 785-1800
FAX +1 (818) 785-5713
moticont@moticont.com









Linear DC Motors Comparison Table

Model #	Stroke		Continuous Force		Intermittent Force @ 10% Duty Cycle		Force Constant		Coil Mass		Body Mass		Housing Outside Diameter		Housing Length	
LVCM-010-013-01	0.25	inch	1.0	oz	3.2	oz	1.0	oz/A	0.09	oz	0.13	oz	0.375	inch	0.500	inch
Datasheet in PDF 	6.4	mm	0.28	N	0.88	N	0.29	N/A	2.5	gr	3.8	gr	9.5	mm	12.7	mm
LVCM-013-013-02	0.25	inch	3.1	oz	9.8	oz	2.5	oz/A	0.19	oz	0.27	oz	0.500	inch	0.500	inch
Datasheet in PDF 	6.4	mm	0.86	N	2.73	N	0.69	N/A	5.4	gr	7.6	gr	12.7	mm	12.7	mm
LVCM-013-019-02	0.50	inch	2.9	oz	9.2	oz	2.8	oz/A	0.23	oz	0.37	oz	0.500	inch	0.750	inch
Datasheet in PDF 	12.7	mm	0.81	N	2.55	N	0.77	N/A	6.4	gr	10.6	gr	12.7	mm	19.1	mm
LVCM-013-025-02	0.75	inch	2.9	oz	9.0	oz	2.9	oz/A	0.32	oz	0.49	oz	0.500	inch	1.000	inch
Datasheet in PDF 	19.1	mm	0.79	N	2.51	N	0.80	N/A	9.0	gr	13.8	gr	12.7	mm	25.4	mm
LVCM-013-032-02	1.00	inch	2.5	oz	7.9	oz	2.7	oz/A	0.38	oz	0.60	oz	0.500	inch	1.250	inch
Datasheet in PDF 	25.4	mm	0.70	N	2.20	N	0.76	N/A	10.8	gr	17	gr	12.7	mm	31.8	mm
LVCM-013-044-02	1.50	inch	2.5	oz	8.0	oz	3.0	oz/A	0.52	oz	0.88	oz	0.500	inch	1.750	inch
Datasheet in PDF 	38.1	mm	0.71	N	2.23	N	0.84	N/A	14.6	gr	25	gr	12.7	mm	44.5	mm



Moticont
 6901 Woodley Avenue
 Van Nuys, California 91406 U.S.A.
 www.moticont.com







Toll Free (888) 785-1804
 +1 (818) 785-1800
 FAX +1 (818) 785-5713
 moticont@moticont.com

LVCM-016-010-01	0.125	inch	5.9	oz	18.6	oz	4.0	oz/A	0.18	oz	0.25	oz	0.625	inch	0.375	inch
Datasheet in PDF 	3.2	mm	1.6	N	5.2	N	1.1	N/A	5.0	gr	7.0	gr	15.9	mm	9.5	mm
LVCM-016-013-01	0.25	inch	6.3	oz	20.0	oz	5.1	oz/A	0.25	oz	0.42	oz	0.625	inch	0.500	inch
Datasheet in PDF 	6.4	mm	1.8	N	5.6	N	1.4	N/A	7.0	gr	12	gr	15.9	mm	12.7	mm
LVCM-016-019-01	0.50	inch	6.1	oz	19.3	oz	6.3	oz/A	0.32	oz	0.60	oz	0.625	inch	0.750	inch
Datasheet in PDF 	12.7	mm	1.7	N	5.4	N	1.7	N/A	9.0	gr	17	gr	15.9	mm	19.1	mm
LVCM-019-016-02	0.25	inch	8.9	oz	28.0	oz	5.28	oz/A	0.28	oz	0.9	oz	0.750	inch	0.875	inch
Datasheet in PDF 	6.4	mm	2.5	N	7.8	N	1.5	N/A	8	gr	26	gr	19.1	mm	22.2	mm
LVCM-019-022-02	0.5	inch	8.1	oz	25.7	oz	5.74	oz/A	0.39	oz	1.3	oz	0.750	inch	0.875	inch
Datasheet in PDF 	12.7	mm	2.3	N	7.1	N	1.6	N/A	11	gr	36	gr	19.1	mm	22.2	mm
LVCM-019-048-02	1.5	inch	7.4	oz	23.5	oz	7.06	oz/A	0.71	oz	2.6	oz	0.750	inch	1.875	inch
Datasheet in PDF 	38.1	mm	2.1	N	6.5	N	2.0	N/A	20	gr	73	gr	19.1	mm	47.6	mm
LVCM-025-022-01	0.38	inch	16.9	oz	53.5	oz	11.1	oz/A	0.71	oz	2.2	oz	1.000	inch	0.875	inch
Datasheet in PDF 	9.5	mm	4.7	N	14.9	N	3.1	N/A	20	gr	62	gr	25.4	mm	22.2	mm
LVCM-025-029-01	0.63	inch	18.2	oz	57.7	oz	13.5	oz/A	0.95	oz	2.8	oz	1.000	inch	1.125	inch
Datasheet in PDF 	15.9	mm	5.1	N	16.0	N	3.75	N/A	27	gr	78	gr	25.4	mm	28.6	mm
LVCM-025-038-02	1.00	inch	16.4	oz	51.9	oz	0.88	lb/A	1.22	oz	3.6	oz	1.000	inch	1.50	inch



Moticont
6901 Woodley Avenue
Van Nuys, California 91406 U.S.A.
www.moticont.com







Toll Free (888) 785-1804
+1 (818) 785-1800
FAX +1 (818) 785-5713
moticont@moticont.com

Datasheet in PDF 	25.4	mm	4.6	N	14.4	N	3.9	N/A	35	gr	102	gr	25.4	mm	38.1	mm
LVCM-032-025-02	0.50	inch	1.5	lb	4.5	lb	0.88	lb/A	0.99	oz	4.5	oz	1.250	inch	1.00	inch
Datasheet in PDF 	12.7	mm	6.7	N	20.1	N	3.9	N/A	28	gr	127	gr	31.8	mm	25.4	mm
LVCM-032-038-02	1.00	inch	1.9	lb	5.9	lb	0.94	lb/A	1.34	oz	6.5	oz	1.250	inch	1.50	inch
Datasheet in PDF 	25.4	mm	8.3	N	26.1	N	4.2	N/A	38	gr	184	gr	31.8	mm	28.6	mm
LVCM-038-038-01	0.75	inch	3.0	lb	9.5	lb	2.3	lb/A	1.90	oz	9.5	oz	1.500	inch	1.50	inch
Datasheet in PDF 	19.1	mm	13.4	N	42.5	N	10.1	N/A	54	gr	270	gr	38.1	mm	38.1	mm
LVCM-044-032-02	0.50	inch	5.0	lb	15.8	lb	2.8	lb/A	2.3	oz	11.3	oz	1.750	inch	1.25	inch
Datasheet in PDF 	12.7	mm	22.2	N	70.4	N	12.3	N/A	64	gr	320	gr	44.5	mm	31.8	mm
LVCM-044-051-01	1.25	inch	4.9	lb	15.4	lb	2.3	lb/A	5.8	oz	14.3	oz	1.750	inch	2.00	inch
Datasheet in PDF 	31.8	mm	21.6	N	68.4	N	10.3	N/A	165	gr	405	gr	44.5	mm	50.8	mm
LVCM-044-051-02	1.25	inch	5.0	lb	15.8	lb	1.6	lb/A	3.2	oz	17.5	oz	1.750	inch	2.00	inch
Datasheet in PDF 	31.8	mm	22.3	N	70.4	N	6.9	N/A	90	gr	497	gr	44.5	mm	50.8	mm
LVCM-051-025-01	0.50	inch	5.3	lb	16.9	lb	1.6	lb/A	3.2	oz	11.5	oz	2.000	inch	1.00	inch

motiCONT

Moticont
6901 Woodley Avenue
Van Nuys, California 91406 U.S.A.
www.moticont.com





Toll Free (888) 785-1804
+1 (818) 785-1800
FAX +1 (818) 785-5713
moticont@moticont.com

Datasheet in PDF 	12.7	mm	23.7	N	74.8	N	6.9	N/A	92	gr	326	gr	50.8	mm	25.4	mm
LVCM-051-032-01	0.75	inch	6.3	lb	20.0	lb	1.9	lb/A	3.6	oz	14.4	oz	2.000	inch	1.25	inch
Datasheet in PDF 	19.1	mm	28.2	N	89.9	N	8.4	N/A	103	gr	409	gr	50.8	mm	31.8	mm
LVCM-051-051-01	0.75	inch	6.3	lb	19.9	lb	1.8	lb/A	4.23	oz	24.2	oz	2.000	inch	2.00	inch
Datasheet in PDF 	19.1	mm	28.0	N	88.6	N	8.0	N/A	120	gr	685	gr	50.8	mm	50.8	mm
LVCM-051-064-01	1.25	inch	6.6	lb	20.9	lb	2.2	lb/A	5.3	oz	30.0	oz	2.000	inch	2.50	inch
Datasheet in PDF 	31.8	mm	29.4	N	92.9	N	9.6	N/A	150	gr	850	gr	50.8	mm	63.5	mm
LVCM-051-089-01	2.25	inch	5.9	lb	18.6	lb	2.3	lb/A	6.9	oz	40.7	oz	2.000	inch	3.50	inch
Datasheet in PDF 	57.2	mm	26.2	N	82.7	N	10.1	N/A	195	gr	1155	gr	50.8	mm	88.9	mm
LVCM-051-165-01	5.25	inch	4.8	lb	15.3	lb	2.4	lb/A	12.0	oz	74.0	oz	2.000	inch	6.50	inch
Datasheet in PDF 	133.4	mm	21.5	N	68.1	N	10.6	N/A	340	gr	2100	gr	50.8	mm	165.1	mm
LVCM-070-038-01	0.50	inch	14.5	lb	45.9	lb	4.7	lb/A	0.42	oz	2.1	lb	2.750	inch	1.50	inch
Datasheet in PDF 	12.7	mm	64.6	N	204.4	N	21.2	N/A	192	gr	0.95	kg	69.9	mm	28.6	mm
LVCM-070-051-01	1.00	inch	14.6	lb	46.0	lb	5.5	lb/A	0.53	oz	2.74	oz	2.750	inch	2.00	inch

motiCont

Moticont
6901 Woodley Avenue
Van Nuys, California 91406 U.S.A.
www.moticont.com

Toll Free (888) 785-1804
+1 (818) 785-1800
FAX +1 (818) 785-5713
motiCont@moticont.com

Datasheet in PDF 	25.4	mm	64.7	N	204.3	N	24.4	N/A	240	gr	1.24	kg	69.9	mm	50.8	mm
LVCM-070-064-01	1.50	inch	14.4	lb	45.5	lb	2.5	lb/A	0.67	oz	3.37	lb	2.750	inch	2.50	inch
Datasheet in PDF 	38.2	mm	64.0	N	202.0	N	11.0	N/A	305	gr	1.53	kg	69.9	mm	63.5	mm
LVCM-095-038-01	0.50	inch	23.1	lb	73.1	lb	8.5	lb/A	0.72	oz	4.07	lb	3.750	inch	1.50	inch
Datasheet in PDF 	12.7	mm	102.7	N	324.4	N	38.0	N/A	326	gr	1.85	kg	95.3	mm	28.6	mm
LVCM-095-051-01	1.00	inch	23.4	lb	70.0	lb	10.1	lb/A	0.87	oz	5.34	lb	3.750	inch	2.0	inch
Datasheet in PDF 	25.4	mm	104.0	N	328.7	N	44.8	N/A	395	gr	2.42	kg	95.3	mm	50.8	mm
LVCM-095-064-01	1.50	inch	24.4	lb	77.1	lb	4.8	lb/A	1.07	lb	6.61	lb	3.750	inch	2.50	inch
Datasheet in PDF 	38.2	mm	108.2	N	342.0	N	21.1	N/A	484	gr	3.00	kg	95.3	mm	63.5	mm

Copyright © 2007, 2008, 2009, 2010, 2011, 2012 MotiCont

motiCont

Moticont
6901 Woodley Avenue
Van Nuys, California 91406 U.S.A.
www.moticont.com

Toll Free (888) 785-1804
+1 (818) 785-1800
FAX +1 (818) 785-5713
moticont@moticont.com

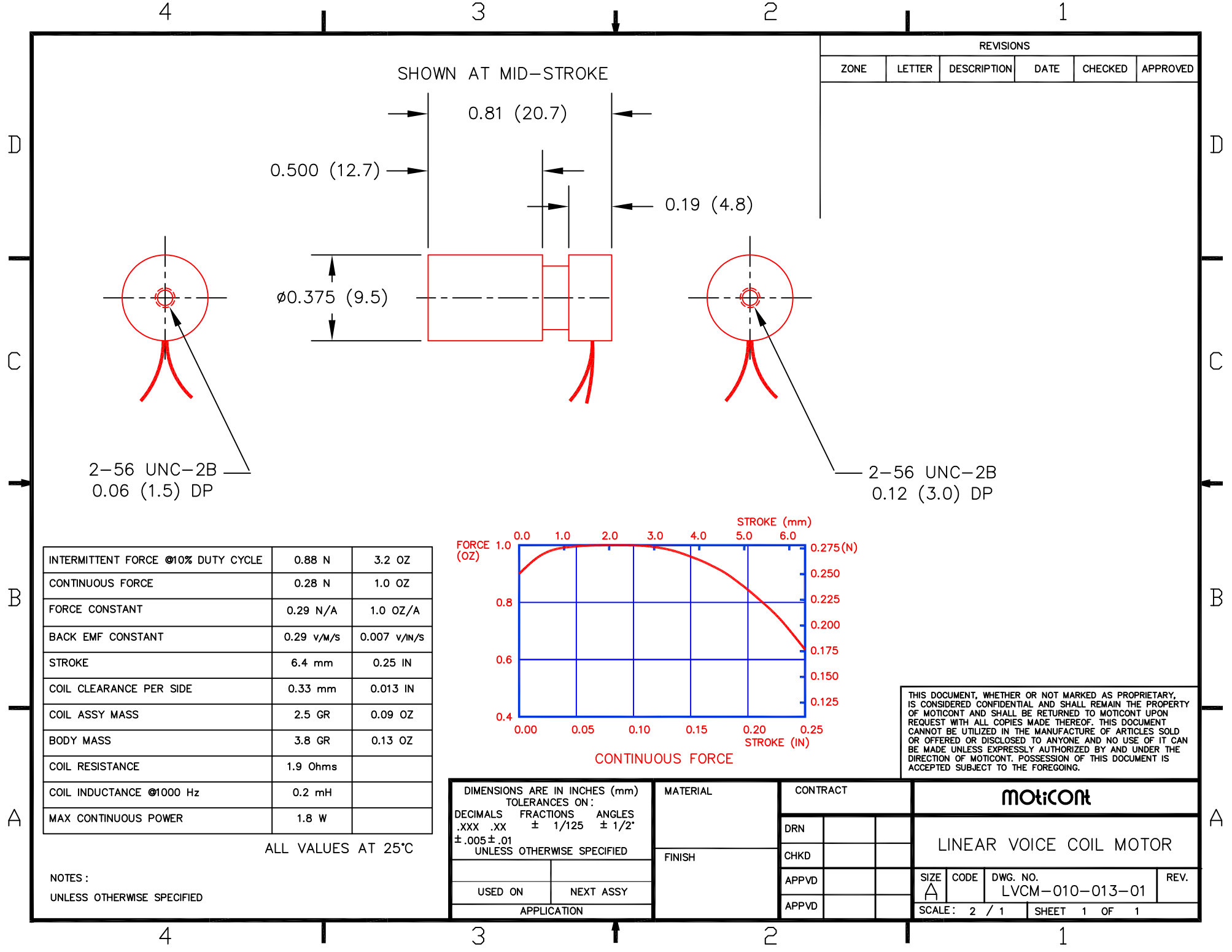

REVISIONS					
ZONE	LETTER	DESCRIPTION	DATE	CHECKED	APPROVED

INTERMITTENT FORCE @10% DUTY CYCLE	0.88 N	3.2 OZ
CONTINUOUS FORCE	0.28 N	1.0 OZ
FORCE CONSTANT	0.29 N/A	1.0 OZ/A
BACK EMF CONSTANT	0.29 v/m/s	0.007 v/m/s
STROKE	6.4 mm	0.25 IN
COIL CLEARANCE PER SIDE	0.33 mm	0.013 IN
COIL ASSY MASS	2.5 GR	0.09 OZ
BODY MASS	3.8 GR	0.13 OZ
COIL RESISTANCE	1.9 Ohms	
COIL INDUCTANCE @1000 Hz	0.2 mH	
MAX CONTINUOUS POWER	1.8 W	

ALL VALUES AT 25°C

NOTES :
UNLESS OTHERWISE SPECIFIED

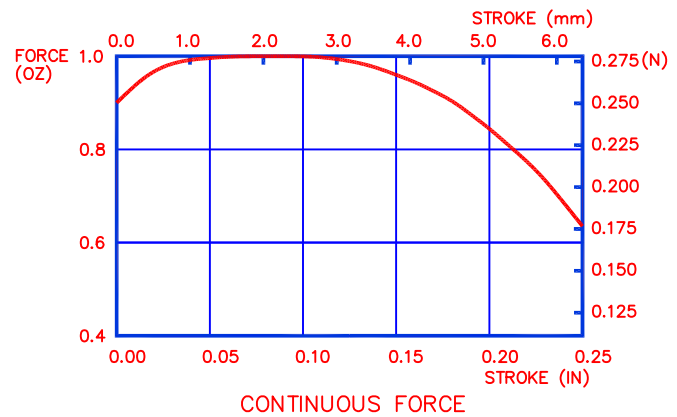

THIS DOCUMENT, WHETHER OR NOT MARKED AS PROPRIETARY, IS CONSIDERED CONFIDENTIAL AND SHALL REMAIN THE PROPERTY OF MOTICONT AND SHALL BE RETURNED TO MOTICONT UPON REQUEST WITH ALL COPIES MADE THEREOF. THIS DOCUMENT CANNOT BE UTILIZED IN THE MANUFACTURE OF ARTICLES SOLD OR OFFERED OR DISCLOSED TO ANYONE AND NO USE OF IT CAN BE MADE UNLESS EXPRESSLY AUTHORIZED BY AND UNDER THE DIRECTION OF MOTICONT. POSSESSION OF THIS DOCUMENT IS ACCEPTED SUBJECT TO THE FOREGOING.

DIMENSIONS ARE IN INCHES (mm) TOLERANCES ON: DECIMALS FRACTIONS ANGLES .XXX .XX ± 1/125 ± 1/2° ± .005 ± .01 UNLESS OTHERWISE SPECIFIED		MATERIAL	CONTRACT					
FINISH		DRN						LINEAR VOICE COIL MOTOR
USED ON	NEXT ASSY	APPVD			SIZE	CODE	DWG. NO.	REV.
APPLICATION		APPVD			A		LVCM-010-013-01	
				SCALE: 2 / 1		SHEET 1 OF 1		

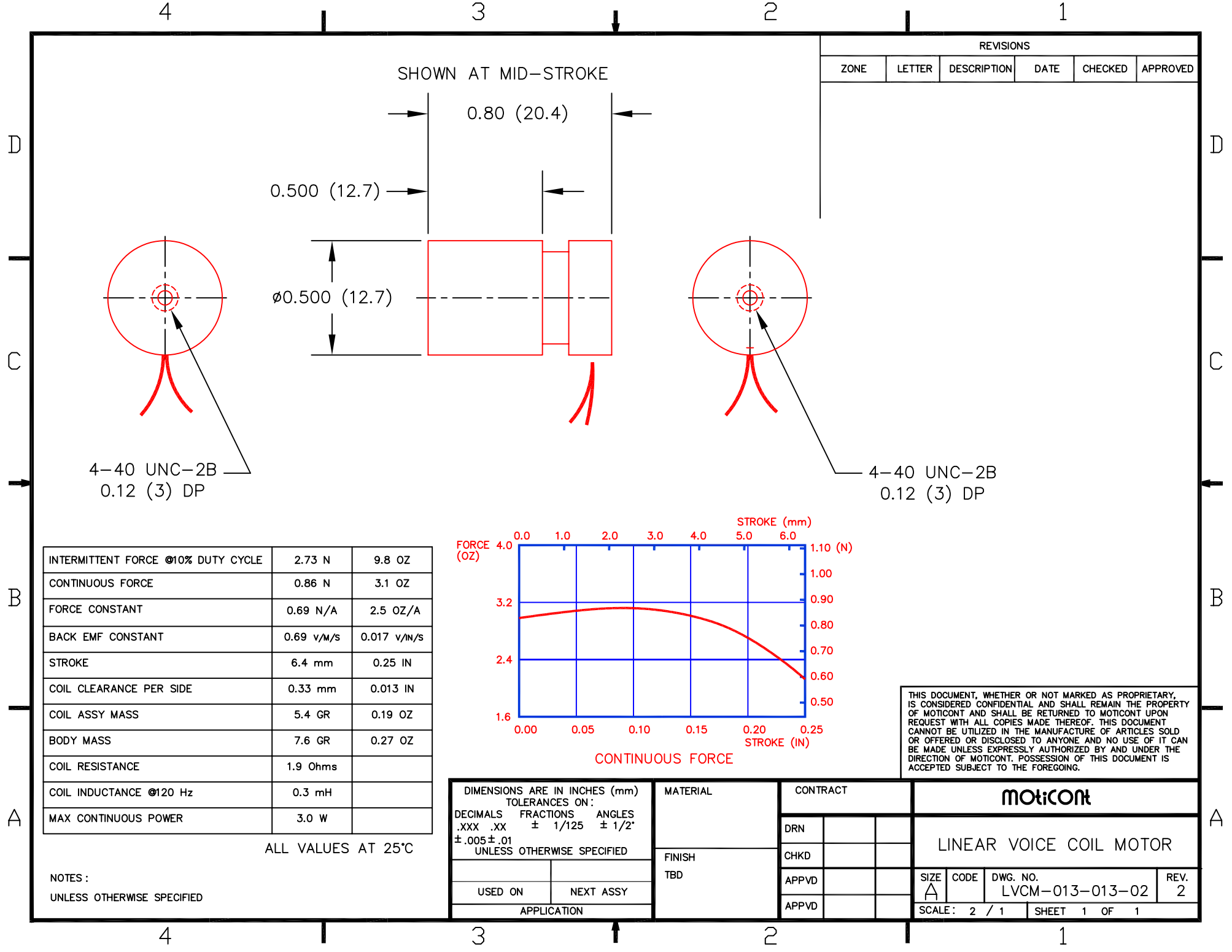

REVISIONS					
ZONE	LETTER	DESCRIPTION	DATE	CHECKED	APPROVED

INTERMITTENT FORCE @10% DUTY CYCLE	2.73 N	9.8 OZ
CONTINUOUS FORCE	0.86 N	3.1 OZ
FORCE CONSTANT	0.69 N/A	2.5 OZ/A
BACK EMF CONSTANT	0.69 v/m/s	0.017 v/in/s
STROKE	6.4 mm	0.25 IN
COIL CLEARANCE PER SIDE	0.33 mm	0.013 IN
COIL ASSY MASS	5.4 GR	0.19 OZ
BODY MASS	7.6 GR	0.27 OZ
COIL RESISTANCE	1.9 Ohms	
COIL INDUCTANCE @120 Hz	0.3 mH	
MAX CONTINUOUS POWER	3.0 W	

ALL VALUES AT 25°C

NOTES :
UNLESS OTHERWISE SPECIFIED

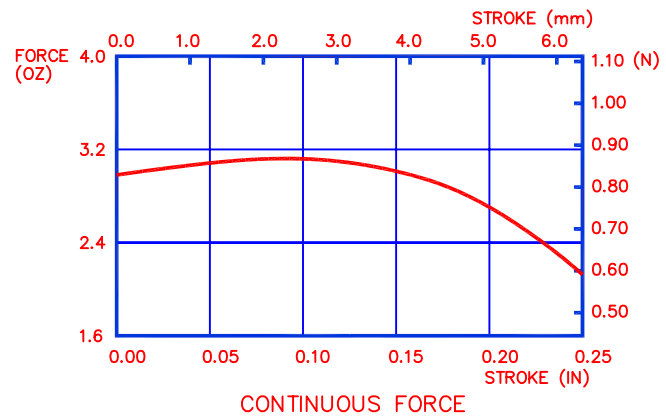

THIS DOCUMENT, WHETHER OR NOT MARKED AS PROPRIETARY, IS CONSIDERED CONFIDENTIAL AND SHALL REMAIN THE PROPERTY OF MOTICONT AND SHALL BE RETURNED TO MOTICONT UPON REQUEST WITH ALL COPIES MADE THEREOF. THIS DOCUMENT CANNOT BE UTILIZED IN THE MANUFACTURE OF ARTICLES SOLD OR OFFERED OR DISCLOSED TO ANYONE AND NO USE OF IT CAN BE MADE UNLESS EXPRESSLY AUTHORIZED BY AND UNDER THE DIRECTION OF MOTICONT. POSSESSION OF THIS DOCUMENT IS ACCEPTED SUBJECT TO THE FOREGOING.

DIMENSIONS ARE IN INCHES (mm) TOLERANCES ON: DECIMALS FRACTIONS ANGLES .XXX .XX ± 1/125 ± 1/2° ± .005 ± .01 UNLESS OTHERWISE SPECIFIED		MATERIAL	CONTRACT		MOTICONT LINEAR VOICE COIL MOTOR					
USED ON		FINISH TBD	DRN						CHKD	
NEXT ASSY			APPVD		APPVD		SIZE	CODE	DWG. NO.	REV.
APPLICATION							A		LVCM-013-013-02	2
							SCALE: 2 / 1		SHEET 1 OF 1	

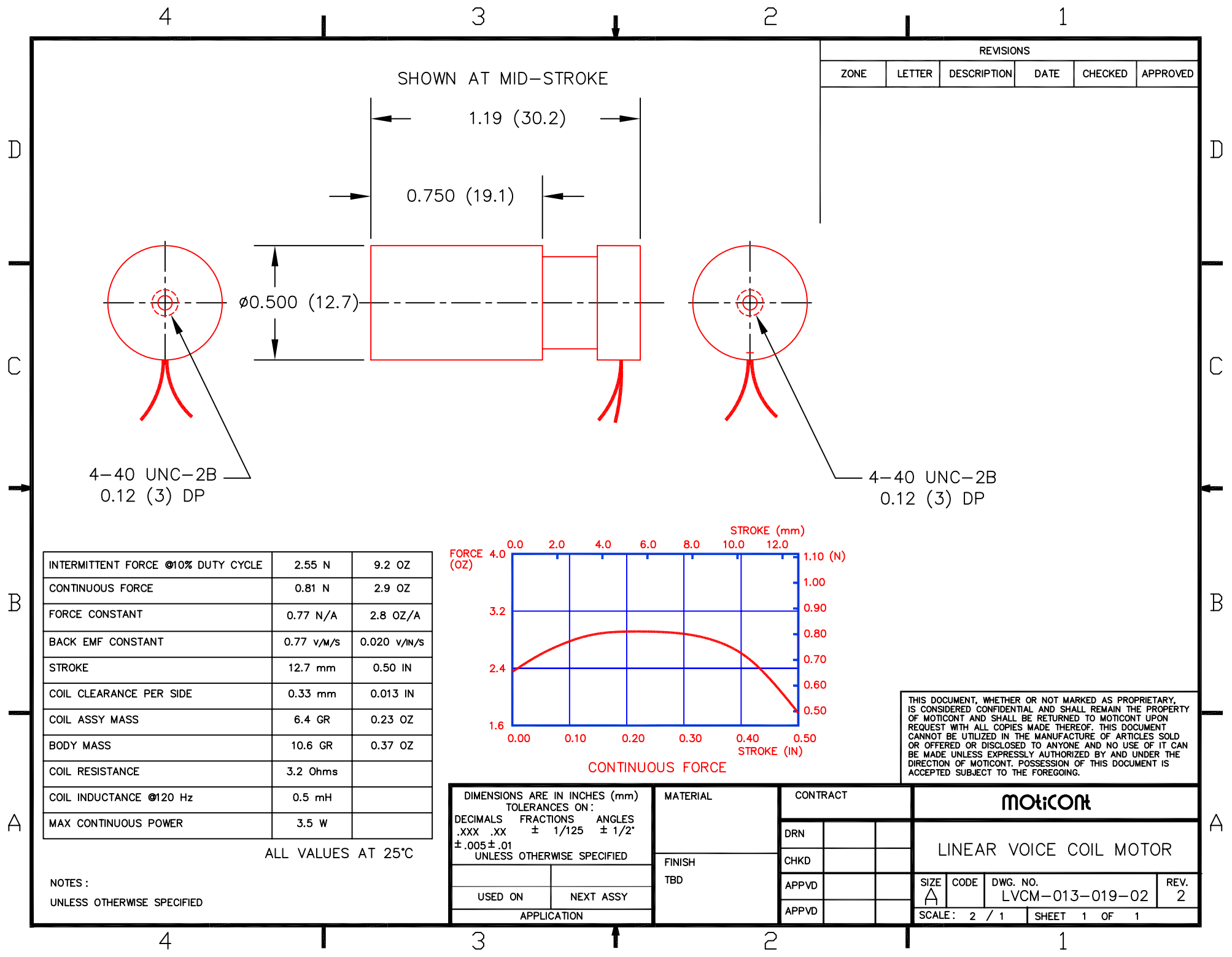

REVISIONS					
ZONE	LETTER	DESCRIPTION	DATE	CHECKED	APPROVED

INTERMITTENT FORCE @10% DUTY CYCLE	2.55 N	9.2 OZ
CONTINUOUS FORCE	0.81 N	2.9 OZ
FORCE CONSTANT	0.77 N/A	2.8 OZ/A
BACK EMF CONSTANT	0.77 v/m/s	0.020 v/in/s
STROKE	12.7 mm	0.50 IN
COIL CLEARANCE PER SIDE	0.33 mm	0.013 IN
COIL ASSY MASS	6.4 GR	0.23 OZ
BODY MASS	10.6 GR	0.37 OZ
COIL RESISTANCE	3.2 Ohms	
COIL INDUCTANCE @120 Hz	0.5 mH	
MAX CONTINUOUS POWER	3.5 W	

ALL VALUES AT 25°C

NOTES:
UNLESS OTHERWISE SPECIFIED

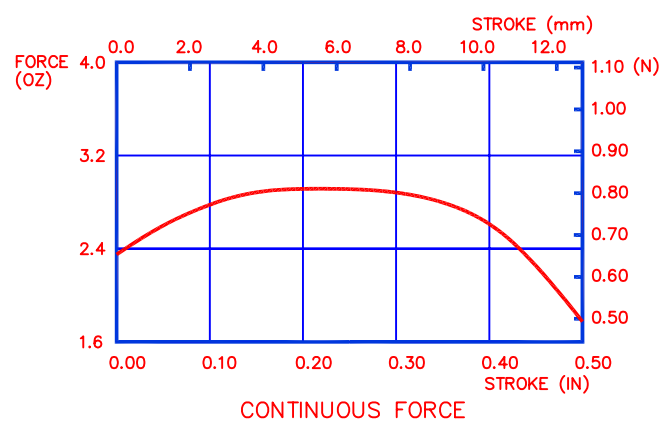

THIS DOCUMENT, WHETHER OR NOT MARKED AS PROPRIETARY, IS CONSIDERED CONFIDENTIAL AND SHALL REMAIN THE PROPERTY OF MOTICONT AND SHALL BE RETURNED TO MOTICONT UPON REQUEST WITH ALL COPIES MADE THEREOF. THIS DOCUMENT CANNOT BE UTILIZED IN THE MANUFACTURE OF ARTICLES SOLD OR OFFERED OR DISCLOSED TO ANYONE AND NO USE OF IT CAN BE MADE UNLESS EXPRESSLY AUTHORIZED BY AND UNDER THE DIRECTION OF MOTICONT. POSSESSION OF THIS DOCUMENT IS ACCEPTED SUBJECT TO THE FOREGOING.

DIMENSIONS ARE IN INCHES (mm) TOLERANCES ON: DECIMALS FRACTIONS ANGLES .XXX .XX ± 1/125 ± 1/2° ± .005 ± .01 UNLESS OTHERWISE SPECIFIED		MATERIAL	CONTRACT		MOTICONT LINEAR VOICE COIL MOTOR				
USED ON		FINISH	DRN	CHKD				APPVD	
NEXT ASSY		TBD	APPVD	APPVD	APPVD	SIZE	CODE	DWG. NO.	REV.
APPLICATION						A		LVCM-013-019-02	2
					SCALE: 2 / 1		SHEET 1 OF 1		

4

3

2

1

SHOWN AT MID-STROKE

REVISIONS					
ZONE	LETTER	DESCRIPTION	DATE	CHECKED	APPROVED

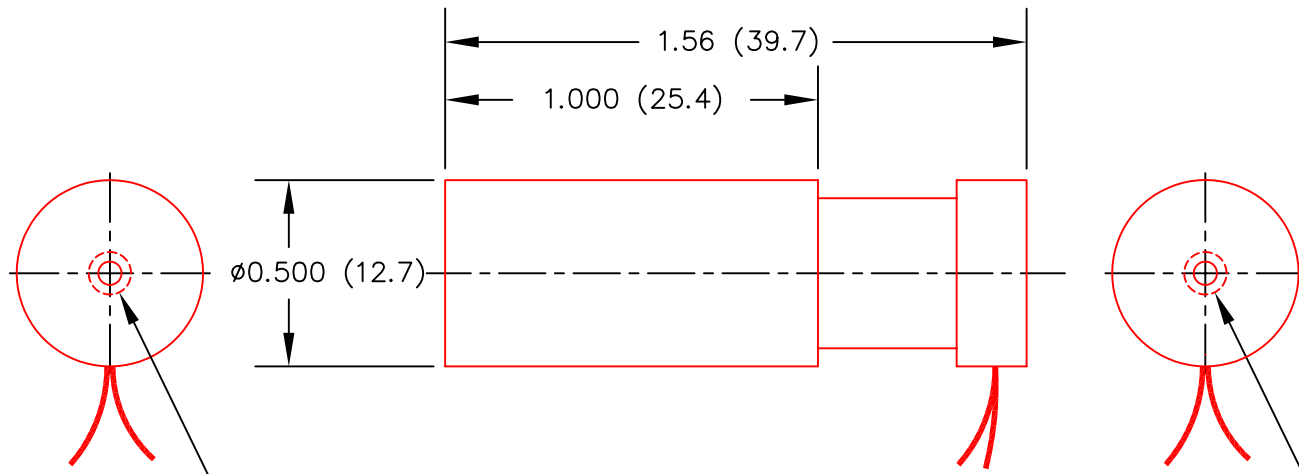

4-40 UNC-2B
0.12 (3) DP

4-40 UNC-2B
0.12 (3) DP

INTERMITTENT FORCE @10% DUTY CYCLE	2.51 N	9.0 OZ
CONTINUOUS FORCE	0.79 N	2.9 OZ
FORCE CONSTANT	0.80 N/A	2.9 OZ/A
BACK EMF CONSTANT	0.80 v/m/s	0.020 v/in/s
STROKE	19.1 mm	0.75 IN
COIL CLEARANCE PER SIDE	0.33 mm	0.013 IN
COIL ASSY MASS	9.0 GR	0.32 OZ
BODY MASS	13.8 GR	0.49 OZ
COIL RESISTANCE	4.6 Ohms	
COIL INDUCTANCE @120 Hz	0.7 mH	
MAX CONTINUOUS POWER	4.5 W	

ALL VALUES AT 25°C

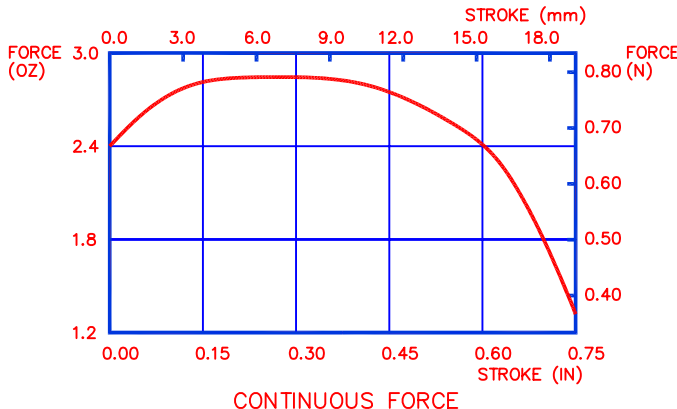

CONTINUOUS FORCE

THIS DOCUMENT, WHETHER OR NOT MARKED AS PROPRIETARY, IS CONSIDERED CONFIDENTIAL AND SHALL REMAIN THE PROPERTY OF MOTICONT AND SHALL BE RETURNED TO MOTICONT UPON REQUEST WITH ALL COPIES MADE THEREOF. THIS DOCUMENT CANNOT BE UTILIZED IN THE MANUFACTURE OF ARTICLES SOLD OR OFFERED OR DISCLOSED TO ANYONE AND NO USE OF IT CAN BE MADE UNLESS EXPRESSLY AUTHORIZED BY AND UNDER THE DIRECTION OF MOTICONT. POSSESSION OF THIS DOCUMENT IS ACCEPTED SUBJECT TO THE FOREGOING.

NOTES :
UNLESS OTHERWISE SPECIFIED

DIMENSIONS ARE IN INCHES (mm) TOLERANCES ON: DECIMALS FRACTIONS ANGLES .XXX .XX ± 1/125 ± 1/2° ± .005 ± .01 UNLESS OTHERWISE SPECIFIED	
USED ON	NEXT ASSY
APPLICATION	

MATERIAL	CONTRACT	
FINISH TBD	DRN	
	CHKD	
	APPVD	
	APPVD	

MOTICONT			
LINEAR VOICE COIL MOTOR			
SIZE A	CODE	DWG. NO. LVCM-013-025-02	REV. 2
SCALE: 2 / 1		SHEET 1 OF 1	

4

3

2

1

4

3

2

1

SHOWN AT MID-STROKE

REVISIONS

ZONE	LETTER	DESCRIPTION	DATE	CHECKED	APPROVED
------	--------	-------------	------	---------	----------

D

D

C

C

B

B

A

A

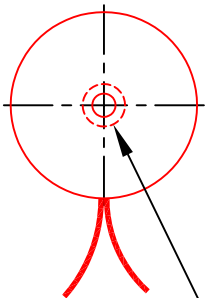

∅0.500 (12.7)

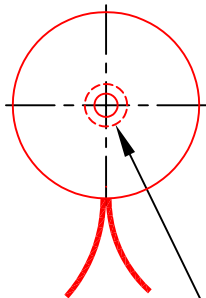
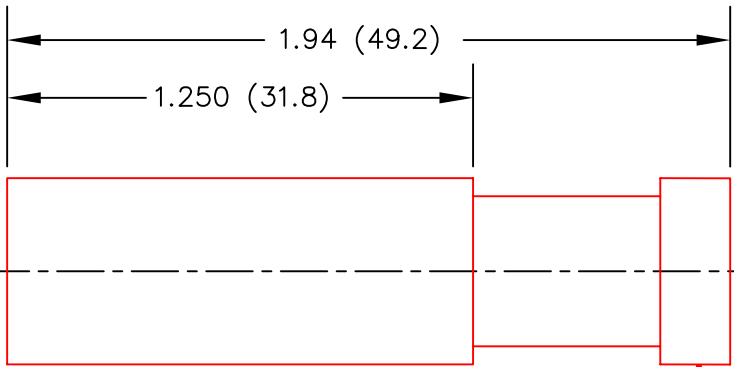

4-40 UNC-2B
0.12 (3) DP

4-40 UNC-2B
0.12 (3) DP

INTERMITTENT FORCE @10% DUTY CYCLE	2.20 N	7.9 OZ
CONTINUOUS FORCE	0.70 N	2.5 OZ
FORCE CONSTANT	0.76 N/A	2.7 OZ/A
BACK EMF CONSTANT	0.76 v/m/s	0.019 v/in/s
STROKE	25.4 mm	1.000 IN
COIL CLEARANCE PER SIDE	0.33 mm	0.013 IN
COIL ASSY MASS	10.8 GR	0.38 OZ
BODY MASS	17 GR	0.60 OZ
COIL RESISTANCE	5.9 Ohms	
COIL INDUCTANCE @120 Hz	1.0 mH	
MAX CONTINUOUS POWER	5.0 W	

ALL VALUES AT 25°C

NOTES :
UNLESS OTHERWISE SPECIFIED

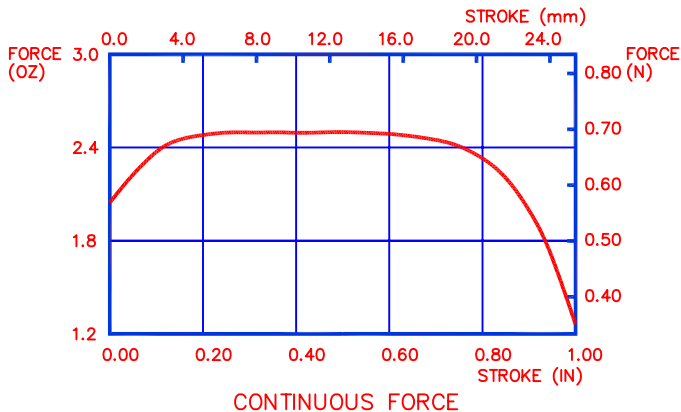

CONTINUOUS FORCE

THIS DOCUMENT, WHETHER OR NOT MARKED AS PROPRIETARY, IS CONSIDERED CONFIDENTIAL AND SHALL REMAIN THE PROPERTY OF MOTICONT AND SHALL BE RETURNED TO MOTICONT UPON REQUEST WITH ALL COPIES MADE THEREOF. THIS DOCUMENT CANNOT BE UTILIZED IN THE MANUFACTURE OF ARTICLES SOLD OR OFFERED OR DISCLOSED TO ANYONE AND NO USE OF IT CAN BE MADE UNLESS EXPRESSLY AUTHORIZED BY AND UNDER THE DIRECTION OF MOTICONT. POSSESSION OF THIS DOCUMENT IS ACCEPTED SUBJECT TO THE FOREGOING.

DIMENSIONS ARE IN INCHES (mm) TOLERANCES ON: DECIMALS FRACTIONS ANGLES .XXX .XX ± 1/125 ± 1/2° ± .005 ± .01 UNLESS OTHERWISE SPECIFIED	
USED ON	NEXT ASSY
APPLICATION	

MATERIAL	CONTRACT
FINISH TBD	DRN
	CHKD
	APPVD
	APPVD

DRN	
CHKD	
APPVD	
APPVD	

MOTICONT			
LINEAR VOICE COIL MOTOR			
SIZE A	CODE	DWG. NO. LVCM-013-032-02	REV. 2
SCALE: 2 / 1		SHEET 1 OF 1	

4

3

2

1

SHOWN AT MID-STROKE

REVISIONS					
ZONE	LETTER	DESCRIPTION	DATE	CHECKED	APPROVED

D

D

C

C

B

B

A

A

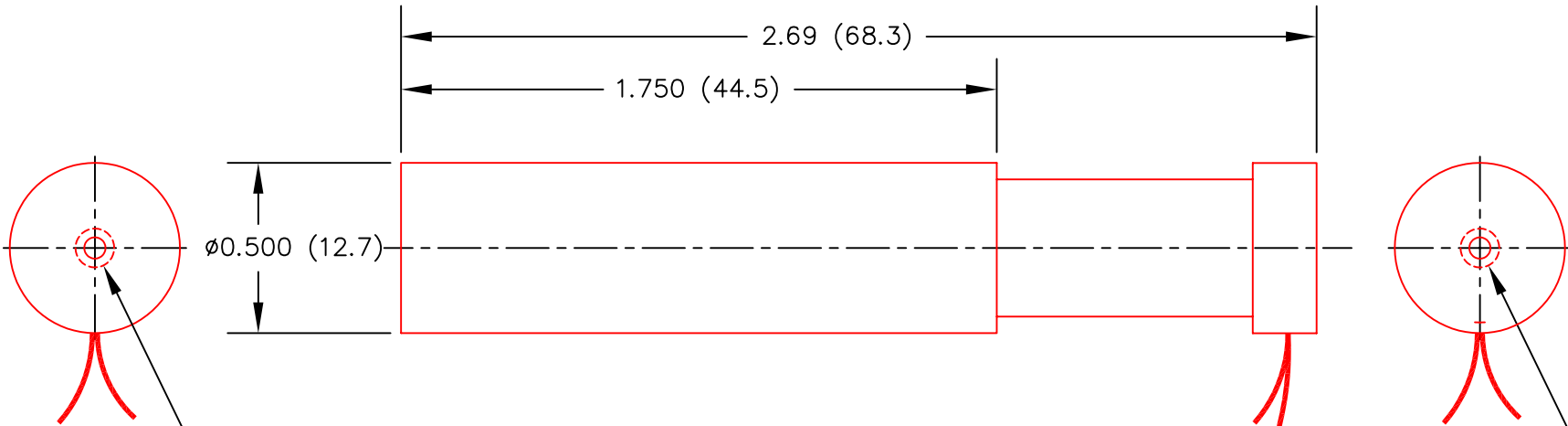

4-40 UNC-2B
0.12 (3) DP

4-40 UNC-2B
0.12 (3) DP

INTERMITTENT FORCE @10% DUTY CYCLE	2.23 N	8.0 OZ
CONTINUOUS FORCE	0.71 N	2.5 OZ
FORCE CONSTANT	0.84 N/A	3.0 OZ/A
BACK EMF CONSTANT	0.84 v/m/s	0.021 v/IN/s
STROKE	38.1 mm	1.50 IN
COIL CLEARANCE PER SIDE	0.33 mm	0.013 IN
COIL ASSY MASS	14.6 GR	0.52 OZ
BODY MASS	25.0 GR	0.88 OZ
COIL RESISTANCE	8.5 Ohms	
COIL INDUCTANCE @120 Hz	1.4 mH	
MAX CONTINUOUS POWER	6.0 W	

ALL VALUES AT 25°C

NOTES:
UNLESS OTHERWISE SPECIFIED

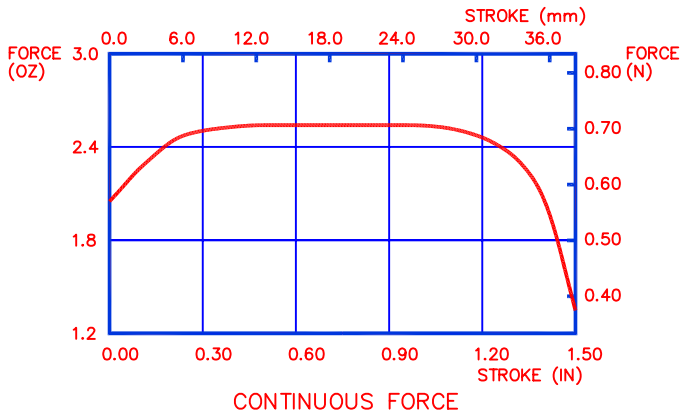

THIS DOCUMENT, WHETHER OR NOT MARKED AS PROPRIETARY, IS CONSIDERED CONFIDENTIAL AND SHALL REMAIN THE PROPERTY OF MOTICONT AND SHALL BE RETURNED TO MOTICONT UPON REQUEST WITH ALL COPIES MADE THEREOF. THIS DOCUMENT CANNOT BE UTILIZED IN THE MANUFACTURE OF ARTICLES SOLD OR OFFERED OR DISCLOSED TO ANYONE AND NO USE OF IT CAN BE MADE UNLESS EXPRESSLY AUTHORIZED BY AND UNDER THE DIRECTION OF MOTICONT. POSSESSION OF THIS DOCUMENT IS ACCEPTED SUBJECT TO THE FOREGOING.

DIMENSIONS ARE IN INCHES (mm) TOLERANCES ON: DECIMALS FRACTIONS ANGLES .XXX .XX ± 1/125 ± 1/2° ± .005 ± .01 UNLESS OTHERWISE SPECIFIED	
USED ON	NEXT ASSY
APPLICATION	

MATERIAL	CONTRACT
FINISH TBD	DRN
	CHKD
	APPVD
	APPVD

DRN	
CHKD	
APPVD	
APPVD	

MOTICONT			
LINEAR VOICE COIL MOTOR			
SIZE A	CODE	DWG. NO. LVCM-013-044-02	REV. 1
SCALE: 2 / 1		SHEET 1 OF 1	

4

3

2

1

REVISIONS

ZONE	LETTER	DESCRIPTION	DATE	CHECKED	APPROVED
------	--------	-------------	------	---------	----------

SHOWN AT MID-STROKE

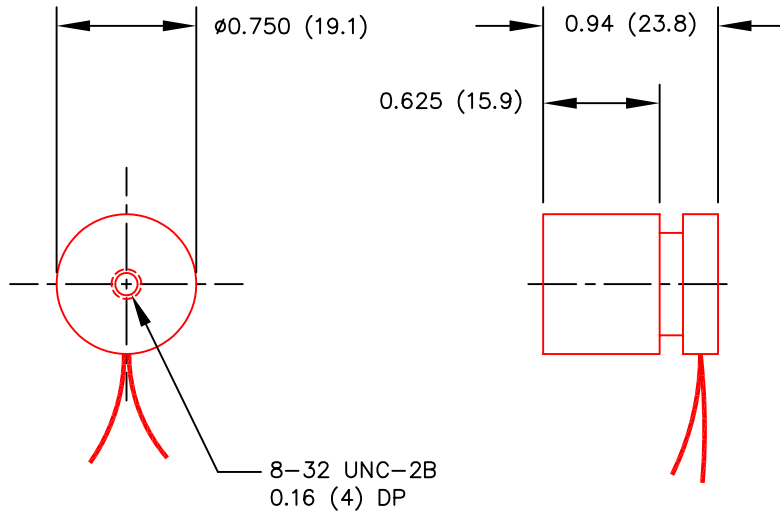
6-32 UNC-2B
0.16 (4) DP

INTERMITTENT FORCE @10% DUTY CYCLE	7.8 N	28.0 OZ
CONTINUOUS FORCE	2.5 N	8.9 OZ
FORCE CONSTANT	1.5 N/A	5.28 OZ/A
BACK EMF CONSTANT	1.5 v/m/s	0.037 v/m/s
STROKE	6.4 mm	0.25 IN
COIL CLEARANCE PER SIDE	0.38 mm	0.015 IN
COIL ASSY MASS	8 GR	0.28 OZ
BODY MASS	26 GR	0.9 OZ
COIL RESISTANCE	1.6 Ohms	
COIL INDUCTANCE @120 Hz	0.37 mH	
MAX CONTINUOUS POWER	4.5 W	

ALL VALUES AT 25°C

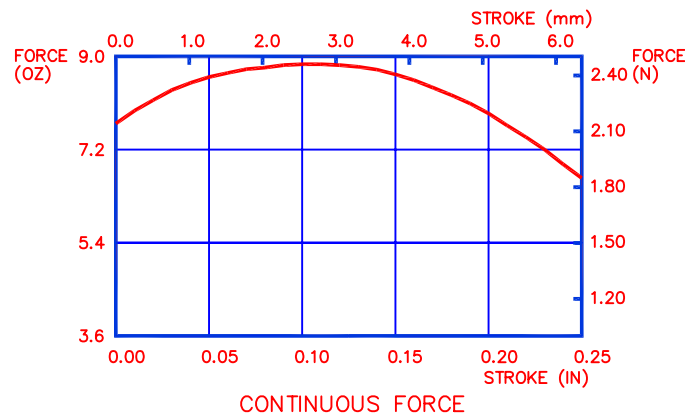
NOTES:
UNLESS OTHERWISE SPECIFIED

THIS DOCUMENT, WHETHER OR NOT MARKED AS PROPRIETARY, IS CONSIDERED CONFIDENTIAL AND SHALL REMAIN THE PROPERTY OF MOTICONT AND SHALL BE RETURNED TO MOTICONT UPON REQUEST WITH ALL COPIES MADE THEREOF. THIS DOCUMENT CANNOT BE UTILIZED IN THE MANUFACTURE OF ARTICLES SOLD OR OFFERED OR DISCLOSED TO ANYONE AND NO USE OF IT CAN BE MADE UNLESS EXPRESSLY AUTHORIZED BY AND UNDER THE DIRECTION OF MOTICONT. POSSESSION OF THIS DOCUMENT IS ACCEPTED SUBJECT TO THE FOREGOING.

DIMENSIONS ARE IN INCHES (mm)
TOLERANCES ON:
DECIMALS FRACTIONS ANGLES
.XXX .XX ± 1/125 ± 1/2°
±.005 ± .01
UNLESS OTHERWISE SPECIFIED

MATERIAL

CONTRACT

motiCont

USED ON

NEXT ASSY

APPLICATION

FINISH

DRN

CHKD

APPVD

APPVD

LINEAR VOICE COIL MOTOR

SIZE
A

CODE

DWG. NO.
LVCM-019-016-02REV.
1

SCALE: 1 / 1

SHEET 1 OF 1

4

3

2

1

4

3

2

1

REVISIONS

ZONE	LETTER	DESCRIPTION	DATE	CHECKED	APPROVED

SHOWN AT MID-STROKE

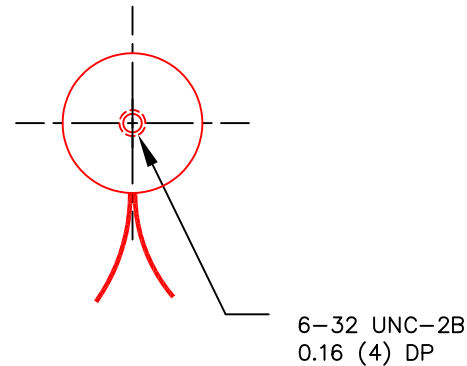
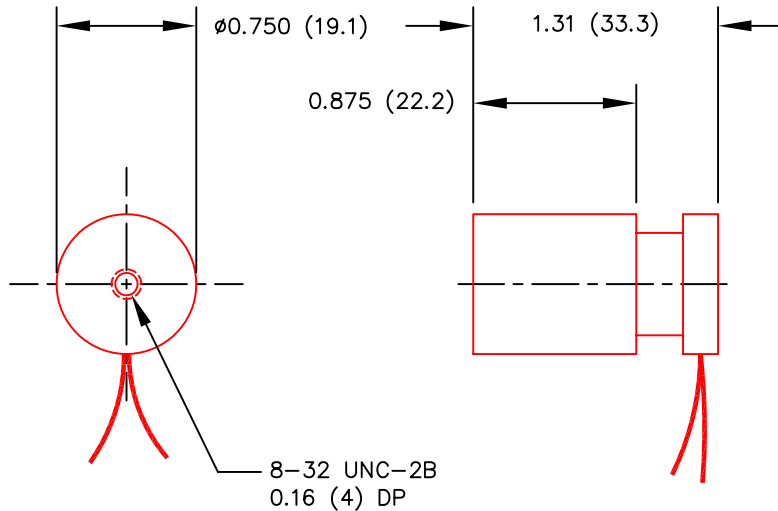

INTERMITTENT FORCE @10% DUTY CYCLE	7.1 N	25.7 OZ
CONTINUOUS FORCE	2.3 N	8.1 OZ
FORCE CONSTANT	1.6 N/A	5.74 OZ/A
BACK EMF CONSTANT	1.6 v/m/s	0.041 v/in/s
STROKE	12.7 mm	0.50 IN
COIL CLEARANCE PER SIDE	0.38 mm	0.015 IN
COIL ASSY MASS	11 GR	0.39 OZ
BODY MASS	36 GR	1.3 OZ
COIL RESISTANCE	2.5 Ohms	
COIL INDUCTANCE @120 Hz	0.57 mH	
MAX CONTINUOUS POWER	5.0 W	

ALL VALUES AT 25°C

NOTES:
UNLESS OTHERWISE SPECIFIED

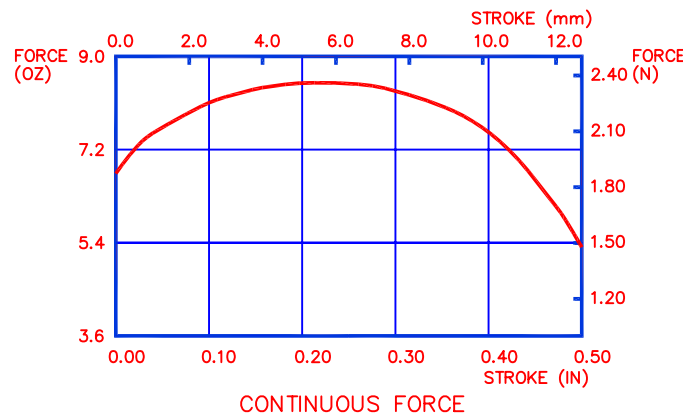

THIS DOCUMENT, WHETHER OR NOT MARKED AS PROPRIETARY, IS CONSIDERED CONFIDENTIAL AND SHALL REMAIN THE PROPERTY OF MOTICONT AND SHALL BE RETURNED TO MOTICONT UPON REQUEST WITH ALL COPIES MADE THEREOF. THIS DOCUMENT CANNOT BE UTILIZED IN THE MANUFACTURE OF ARTICLES SOLD OR OFFERED OR DISCLOSED TO ANYONE AND NO USE OF IT CAN BE MADE UNLESS EXPRESSLY AUTHORIZED BY AND UNDER THE DIRECTION OF MOTICONT. POSSESSION OF THIS DOCUMENT IS ACCEPTED SUBJECT TO THE FOREGOING.

DIMENSIONS ARE IN INCHES (mm)
TOLERANCES ON:
DECIMALS FRACTIONS ANGLES
.XXX .XX ± 1/125 ± 1/2°
± .005 ± .01
UNLESS OTHERWISE SPECIFIED

USED ON	NEXT ASSY
APPLICATION	

MATERIAL

FINISH

CONTRACT

DRN

CHKD

APPVD

APPVD

motiCont

LINEAR VOICE COIL MOTOR

SIZE	CODE	DWG. NO.	REV.
A		LVCM-019-022-02	1

SCALE: 1 / 1	SHEET 1 OF 1
--------------	--------------

4

3

2

1

4

3

2

1

REVISIONS

ZONE	LETTER	DESCRIPTION	DATE	CHECKED	APPROVED
------	--------	-------------	------	---------	----------

SHOWN AT MID-STROKE

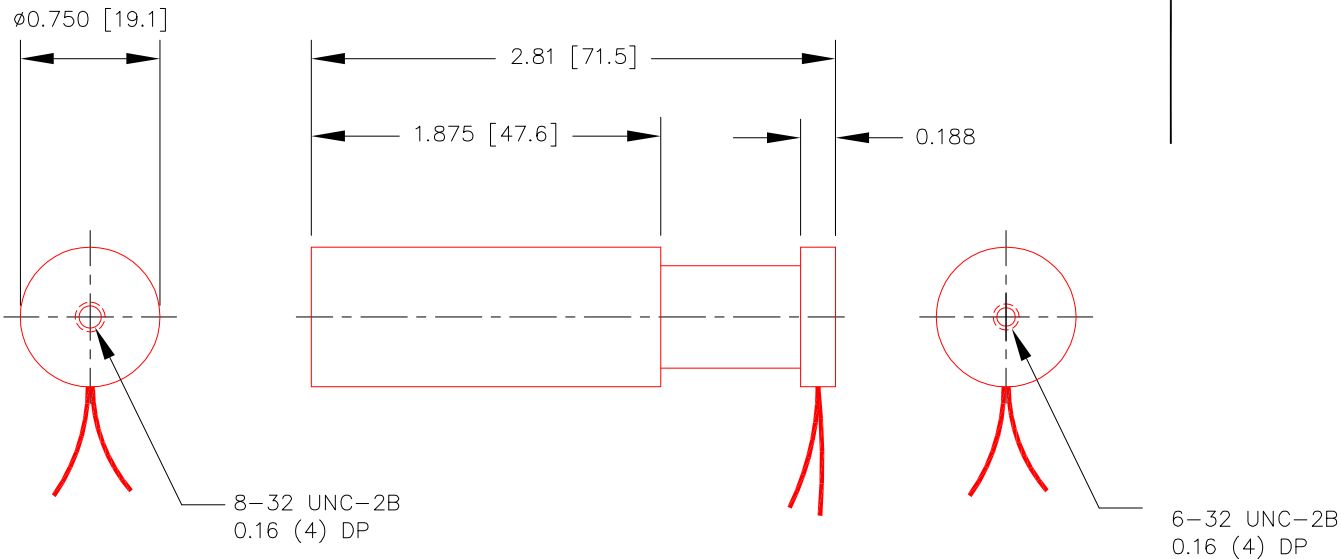

INTERMITTENT FORCE @10% DUTY CYCLE	6.5 N	23.5 OZ
CONTINUOUS FORCE	2.1 N	7.4 OZ
FORCE CONSTANT	2.0 N/A	7.06 OZ/A
BACK EMF CONSTANT	2.0 v/m/s	0.050 v/in/s
STROKE	38.1 mm	1.50 IN
COIL CLEARANCE PER SIDE	0.38 mm	0.015 IN
COIL ASSY MASS	20 GR	0.71 OZ
BODY MASS	73 GR	2.6 OZ
COIL RESISTANCE	7.2 Ohms	
COIL INDUCTANCE @ 1000 Hz	1.4 mH	
MAX CONTINUOUS POWER	8.0 W	

ALL VALUES AT 25°C

NOTES :
UNLESS OTHERWISE SPECIFIED

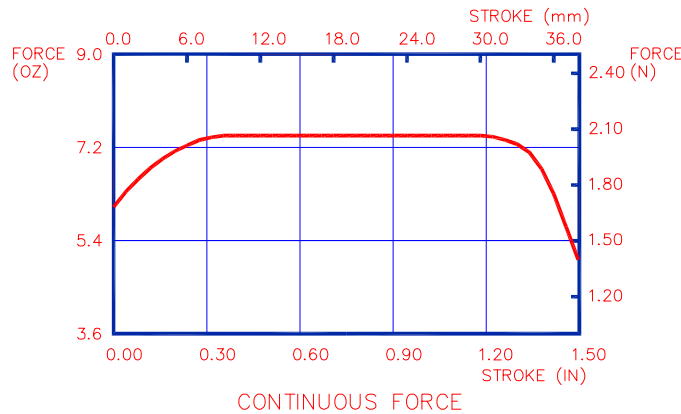

THIS DOCUMENT, WHETHER OR NOT MARKED AS PROPRIETARY, IS CONSIDERED CONFIDENTIAL AND SHALL REMAIN THE PROPERTY OF MOTICONT AND SHALL BE RETURNED TO MOTICONT UPON REQUEST WITH ALL COPIES MADE THEREOF. THIS DOCUMENT CANNOT BE UTILIZED IN THE MANUFACTURE OF ARTICLES SOLD OR OFFERED OR DISCLOSED TO ANYONE AND NO USE OF IT CAN BE MADE UNLESS EXPRESSLY AUTHORIZED BY AND UNDER THE DIRECTION OF MOTICONT. POSSESSION OF THIS DOCUMENT IS ACCEPTED SUBJECT TO THE FOREGOING.

DIMENSIONS ARE IN INCHES (mm) TOLERANCES ON: DECIMALS FRACTIONS ANGLES .XXX .XX ± 1/125 ± 1/2' ± .005 ± .01 UNLESS OTHERWISE SPECIFIED	
USED ON	NEXT ASSY
APPLICATION	

MATERIAL	CONTRACT	
FINISH	DRN	
	CHKD	
	APPVD	
	APPVD	

motiCont			
LINEAR VOICE COIL MOTOR			
SIZE	CODE	DWG. NO.	REV.
A		LVCM-019-048-02	1
SCALE: 1 / 1		SHEET 1 OF 1	

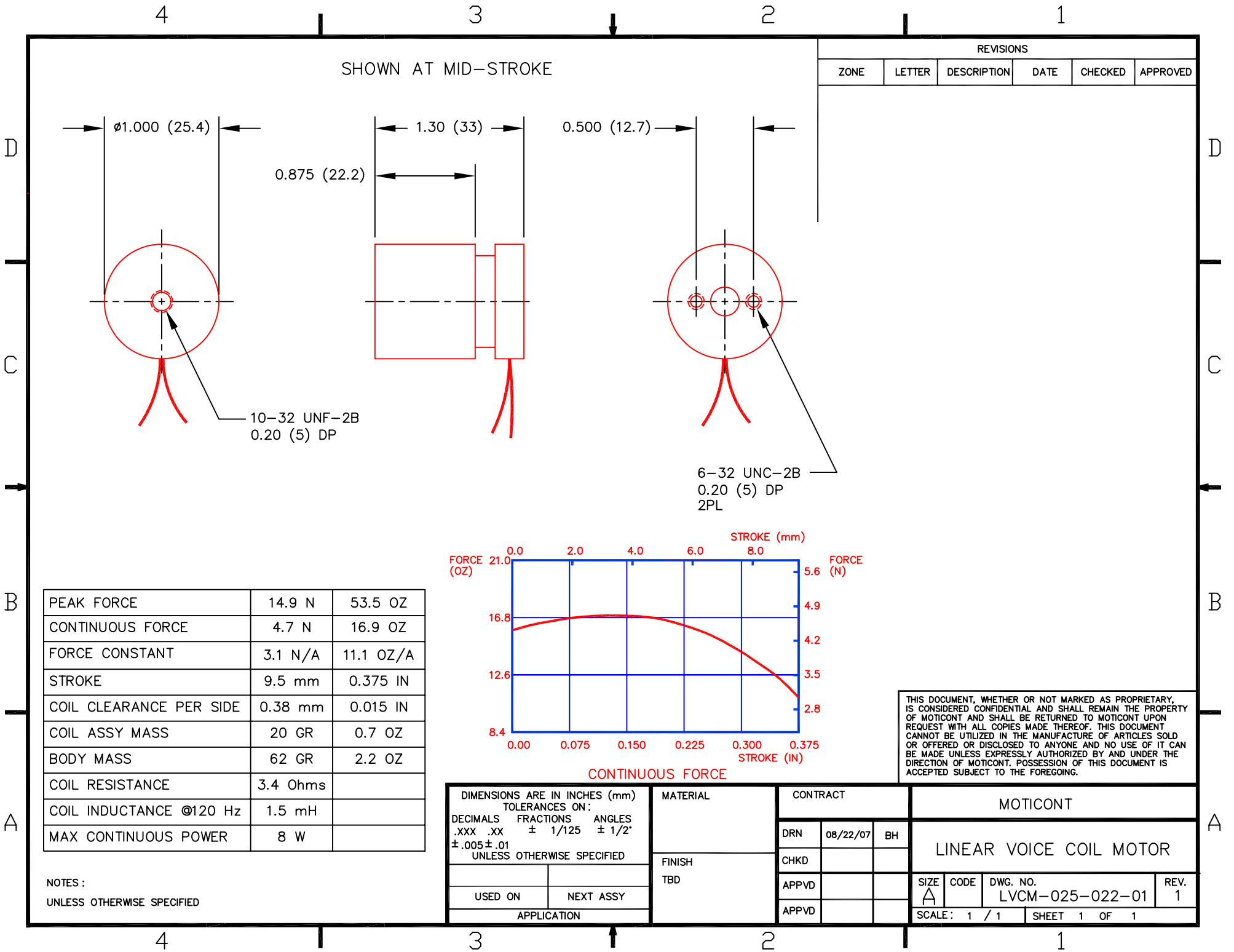

REVISIONS					
ZONE	LETTER	DESCRIPTION	DATE	CHECKED	APPROVED

PEAK FORCE	14.9 N	53.5 OZ
CONTINUOUS FORCE	4.7 N	16.9 OZ
FORCE CONSTANT	3.1 N/A	11.1 OZ/A
STROKE	9.5 mm	0.375 IN
COIL CLEARANCE PER SIDE	0.38 mm	0.015 IN
COIL ASSY MASS	20 GR	0.7 OZ
BODY MASS	62 GR	2.2 OZ
COIL RESISTANCE	3.4 Ohms	
COIL INDUCTANCE @120 Hz	1.5 mH	
MAX CONTINUOUS POWER	8 W	

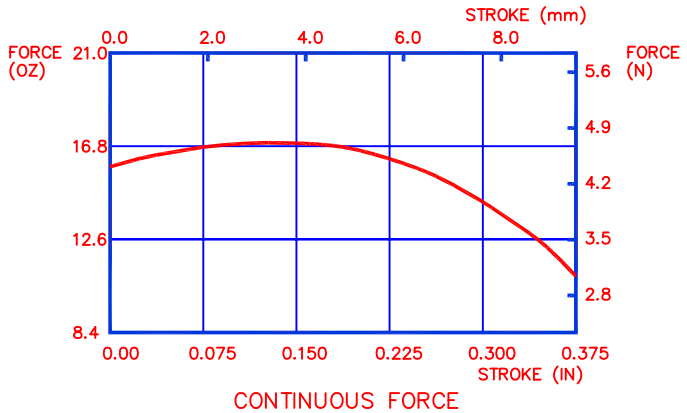

THIS DOCUMENT, WHETHER OR NOT MARKED AS PROPRIETARY, IS CONSIDERED CONFIDENTIAL AND SHALL REMAIN THE PROPERTY OF MOTICONT AND SHALL BE RETURNED TO MOTICONT UPON REQUEST WITH ALL COPIES MADE THEREOF. THIS DOCUMENT CANNOT BE UTILIZED IN THE MANUFACTURE OF ARTICLES SOLD OR OFFERED OR DISCLOSED TO ANYONE AND NO USE OF IT CAN BE MADE UNLESS EXPRESSLY AUTHORIZED BY AND UNDER THE DIRECTION OF MOTICONT. POSSESSION OF THIS DOCUMENT IS ACCEPTED SUBJECT TO THE FOREGOING.

NOTES :
UNLESS OTHERWISE SPECIFIED

DIMENSIONS ARE IN INCHES (mm) TOLERANCES ON: DECIMALS FRACTIONS ANGLES .XXX .XX ± 1/125 ± 1/2° ± .005 ± .01 UNLESS OTHERWISE SPECIFIED	MATERIAL	CONTRACT		MOTICONT				
	FINISH TBD	DRN	08/22/07	BH	LINEAR VOICE COIL MOTOR			
USED ON	NEXT ASSY	CHKD			SIZE	CODE	DWG. NO.	REV.
APPLICATION		APPVD			A		LVCM-025-022-01	1
		APPVD			SCALE: 1 / 1		SHEET 1 OF 1	

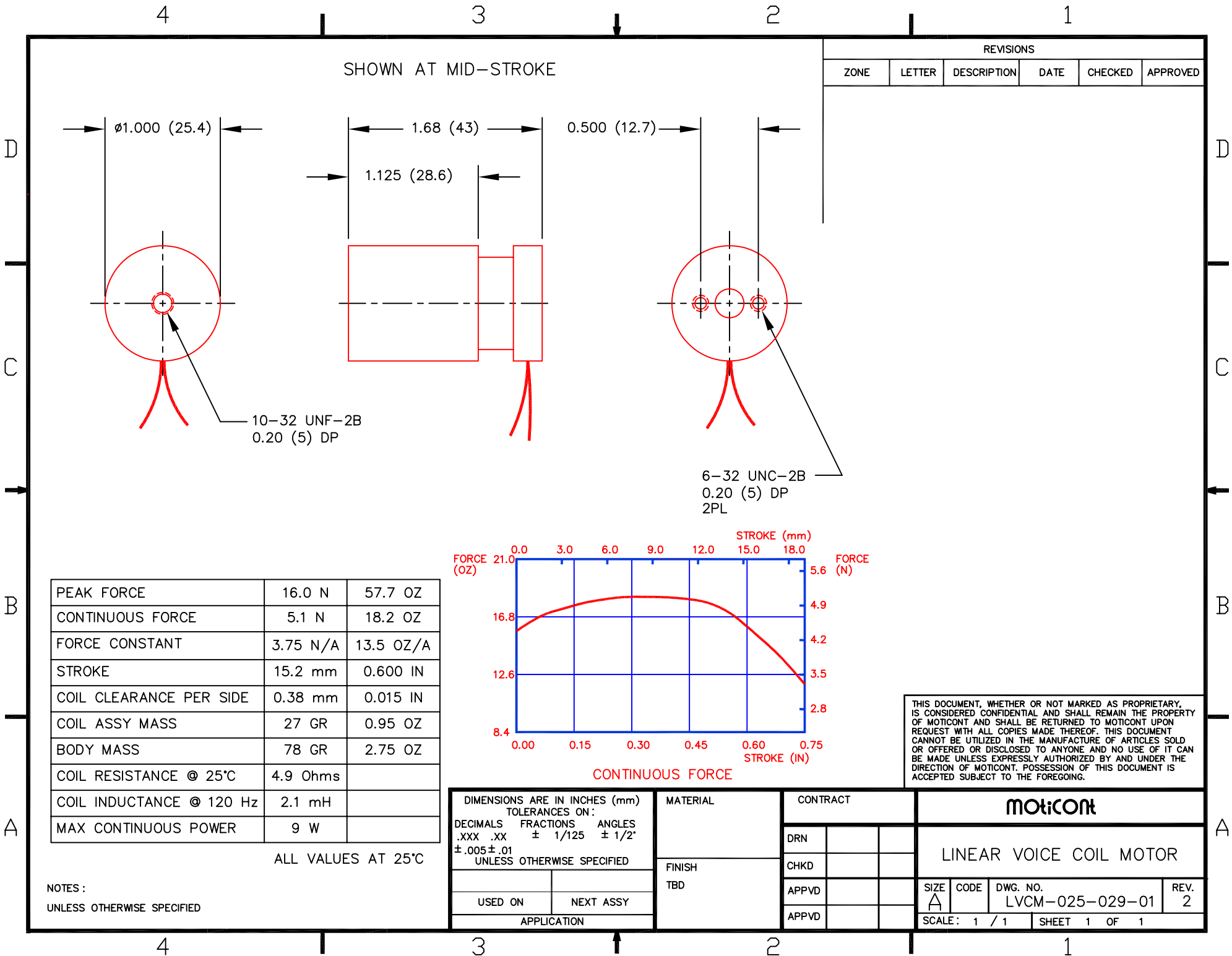

SHOWN AT MID-STROKE

REVISIONS

ZONE	LETTER	DESCRIPTION	DATE	CHECKED	APPROVED
------	--------	-------------	------	---------	----------

← $\phi 1.000 (25.4)$ →

← 1.68 (43) →
← 1.125 (28.6) →

← 0.500 (12.7) →

10-32 UNF-2B
0.20 (5) DP

6-32 UNC-2B
0.20 (5) DP
2PL

PEAK FORCE	16.0 N	57.7 OZ
CONTINUOUS FORCE	5.1 N	18.2 OZ
FORCE CONSTANT	3.75 N/A	13.5 OZ/A
STROKE	15.2 mm	0.600 IN
COIL CLEARANCE PER SIDE	0.38 mm	0.015 IN
COIL ASSY MASS	27 GR	0.95 OZ
BODY MASS	78 GR	2.75 OZ
COIL RESISTANCE @ 25°C	4.9 Ohms	
COIL INDUCTANCE @ 120 Hz	2.1 mH	
MAX CONTINUOUS POWER	9 W	

ALL VALUES AT 25°C

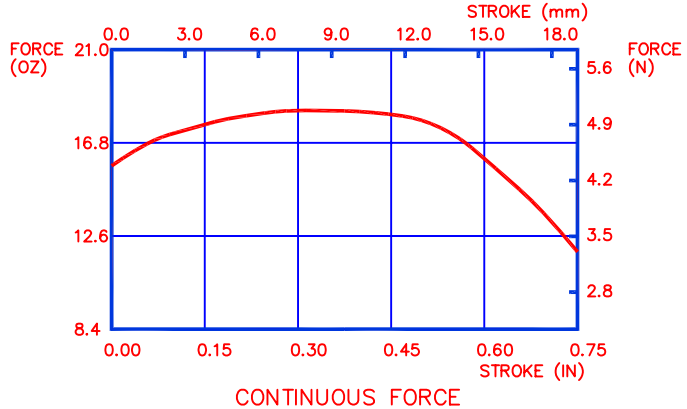

THIS DOCUMENT, WHETHER OR NOT MARKED AS PROPRIETARY, IS CONSIDERED CONFIDENTIAL AND SHALL REMAIN THE PROPERTY OF MOTICONT AND SHALL BE RETURNED TO MOTICONT UPON REQUEST WITH ALL COPIES MADE THEREOF. THIS DOCUMENT CANNOT BE UTILIZED IN THE MANUFACTURE OF ARTICLES SOLD OR OFFERED OR DISCLOSED TO ANYONE AND NO USE OF IT CAN BE MADE UNLESS EXPRESSLY AUTHORIZED BY AND UNDER THE DIRECTION OF MOTICONT. POSSESSION OF THIS DOCUMENT IS ACCEPTED SUBJECT TO THE FOREGOING.

NOTES:
UNLESS OTHERWISE SPECIFIED

DIMENSIONS ARE IN INCHES (mm) TOLERANCES ON: DECIMALS FRACTIONS ANGLES .XXX .XX ± 1/125 ± 1/2' ± .005 ± .01 UNLESS OTHERWISE SPECIFIED		MATERIAL	CONTRACT		MotiCont LINEAR VOICE COIL MOTOR			
USED ON		FINISH TBD	DRN					
NEXT ASSY			CHKD		A		LVCM-025-029-01	2
APPLICATION			APPVD		SCALE: 1 / 1		SHEET 1 OF 1	

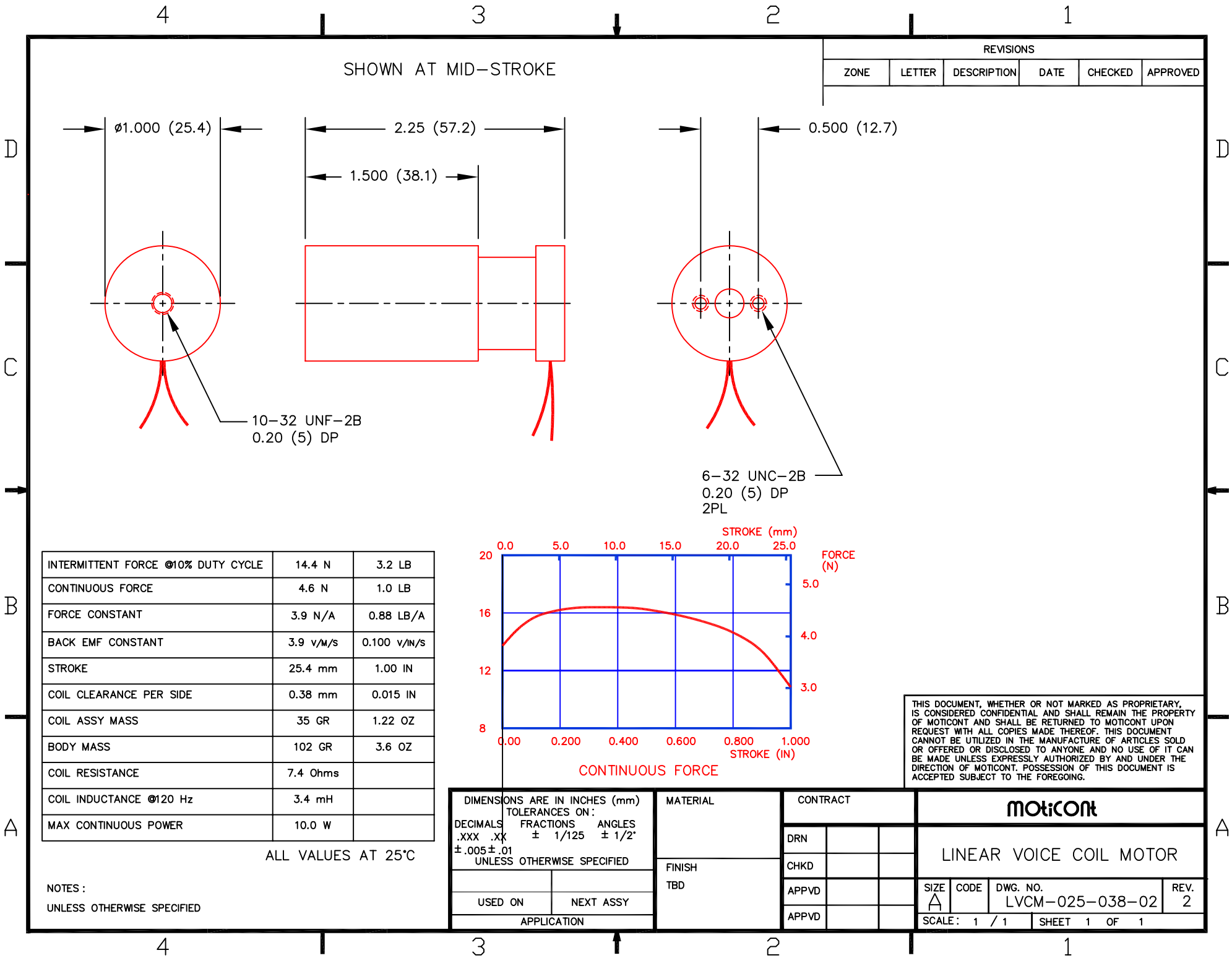

SHOWN AT MID-STROKE

REVISIONS

ZONE	LETTER	DESCRIPTION	DATE	CHECKED	APPROVED
------	--------	-------------	------	---------	----------

INTERMITTENT FORCE @10% DUTY CYCLE	14.4 N	3.2 LB
CONTINUOUS FORCE	4.6 N	1.0 LB
FORCE CONSTANT	3.9 N/A	0.88 LB/A
BACK EMF CONSTANT	3.9 v/m/s	0.100 v/in/s
STROKE	25.4 mm	1.00 IN
COIL CLEARANCE PER SIDE	0.38 mm	0.015 IN
COIL ASSY MASS	35 GR	1.22 OZ
BODY MASS	102 GR	3.6 OZ
COIL RESISTANCE	7.4 Ohms	
COIL INDUCTANCE @120 Hz	3.4 mH	
MAX CONTINUOUS POWER	10.0 W	

ALL VALUES AT 25°C

NOTES :
UNLESS OTHERWISE SPECIFIED

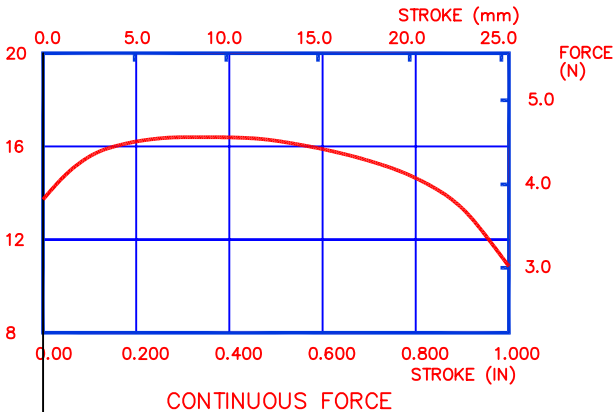

THIS DOCUMENT, WHETHER OR NOT MARKED AS PROPRIETARY, IS CONSIDERED CONFIDENTIAL AND SHALL REMAIN THE PROPERTY OF MOTICONT AND SHALL BE RETURNED TO MOTICONT UPON REQUEST WITH ALL COPIES MADE THEREOF. THIS DOCUMENT CANNOT BE UTILIZED IN THE MANUFACTURE OF ARTICLES SOLD OR OFFERED OR DISCLOSED TO ANYONE AND NO USE OF IT CAN BE MADE UNLESS EXPRESSLY AUTHORIZED BY AND UNDER THE DIRECTION OF MOTICONT. POSSESSION OF THIS DOCUMENT IS ACCEPTED SUBJECT TO THE FOREGOING.

DIMENSIONS ARE IN INCHES (mm)	
TOLERANCES ON:	
DECIMALS	FRACTIONS
.XXX .XX	± 1/125 ± 1/2"
± .005 ± .01	UNLESS OTHERWISE SPECIFIED
USED ON	NEXT ASSY
APPLICATION	

MATERIAL	CONTRACT
FINISH	DRN
TBD	CHKD
	APPVD
	APPVD

DRN	
CHKD	
APPVD	
APPVD	

MOTICONT			
LINEAR VOICE COIL MOTOR			
SIZE	CODE	DWG. NO.	REV.
A		LVCM-025-038-02	2
SCALE: 1 / 1		SHEET 1 OF 1	

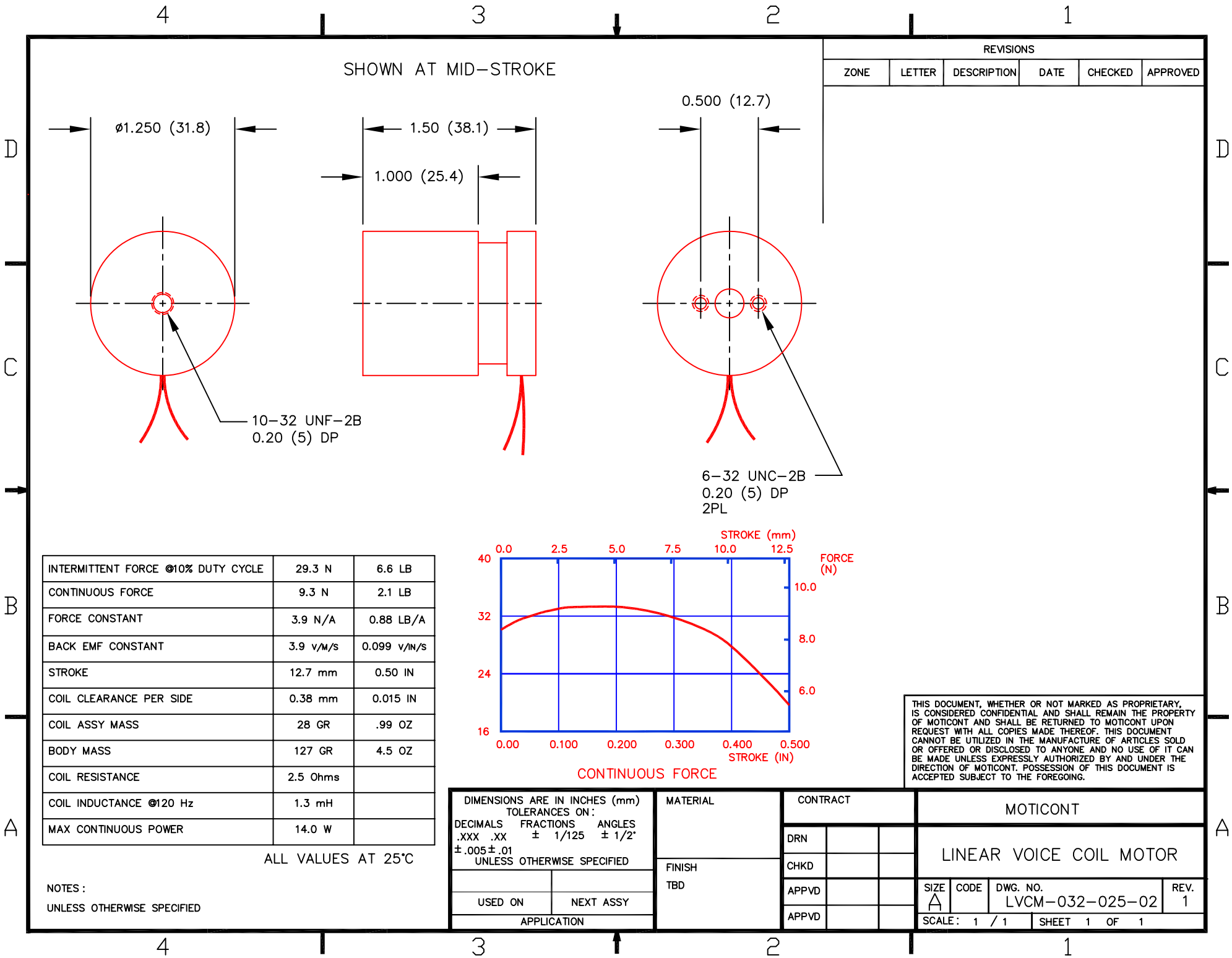

SHOWN AT MID-STROKE

REVISIONS

ZONE	LETTER	DESCRIPTION	DATE	CHECKED	APPROVED
------	--------	-------------	------	---------	----------

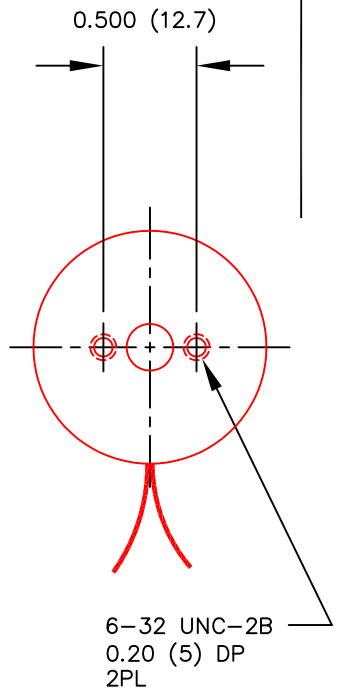
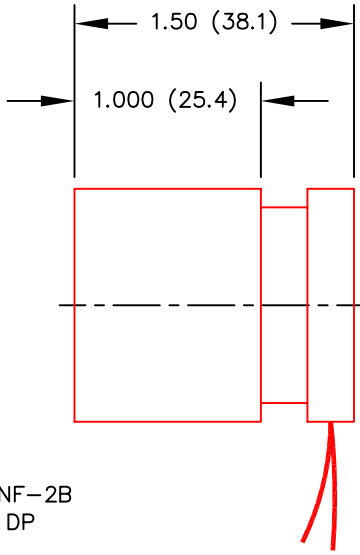
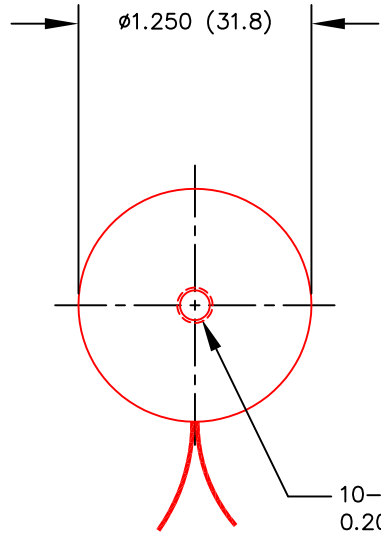

INTERMITTENT FORCE @10% DUTY CYCLE	29.3 N	6.6 LB
CONTINUOUS FORCE	9.3 N	2.1 LB
FORCE CONSTANT	3.9 N/A	0.88 LB/A
BACK EMF CONSTANT	3.9 v/M/s	0.099 v/M/s
STROKE	12.7 mm	0.50 IN
COIL CLEARANCE PER SIDE	0.38 mm	0.015 IN
COIL ASSY MASS	28 GR	.99 OZ
BODY MASS	127 GR	4.5 OZ
COIL RESISTANCE	2.5 Ohms	
COIL INDUCTANCE @120 Hz	1.3 mH	
MAX CONTINUOUS POWER	14.0 W	

ALL VALUES AT 25°C

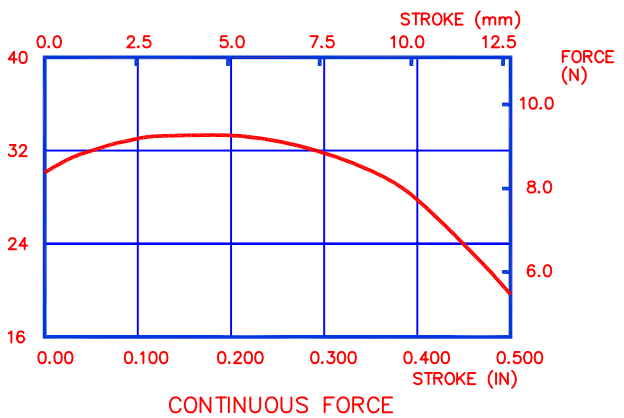

THIS DOCUMENT, WHETHER OR NOT MARKED AS PROPRIETARY, IS CONSIDERED CONFIDENTIAL AND SHALL REMAIN THE PROPERTY OF MOTICONT AND SHALL BE RETURNED TO MOTICONT UPON REQUEST WITH ALL COPIES MADE THEREOF. THIS DOCUMENT CANNOT BE UTILIZED IN THE MANUFACTURE OF ARTICLES SOLD OR OFFERED OR DISCLOSED TO ANYONE AND NO USE OF IT CAN BE MADE UNLESS EXPRESSLY AUTHORIZED BY AND UNDER THE DIRECTION OF MOTICONT. POSSESSION OF THIS DOCUMENT IS ACCEPTED SUBJECT TO THE FOREGOING.

NOTES :
UNLESS OTHERWISE SPECIFIED

DIMENSIONS ARE IN INCHES (mm) TOLERANCES ON: DECIMALS FRACTIONS ANGLES .XXX .XX ± 1/125 ± 1/2° ± .005 ± .01 UNLESS OTHERWISE SPECIFIED		MATERIAL	CONTRACT		MOTICONT			
FINISH TBD			DRN		LINEAR VOICE COIL MOTOR			
USED ON		NEXT ASSY	CHKD		SIZE	CODE	DWG. NO.	REV.
APPLICATION			APPVD		A		LVCM-032-025-02	1
			APPVD		SCALE: 1 / 1		SHEET 1 OF 1	

4

3

2

1

SHOWN AT MID-STROKE

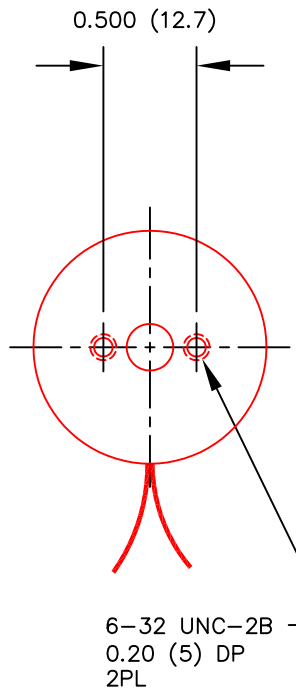
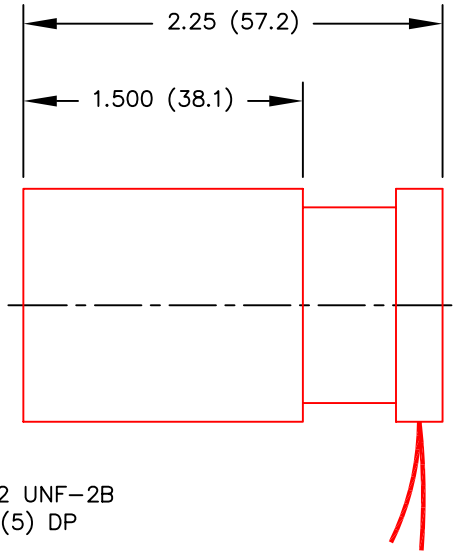
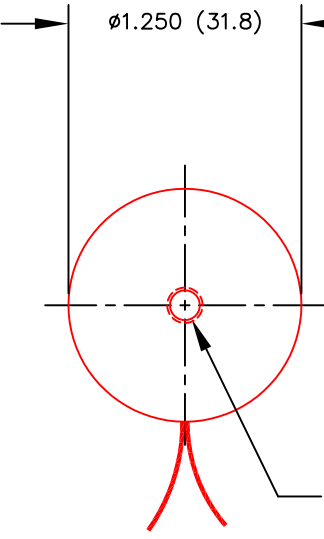

REVISIONS					
ZONE	LETTER	DESCRIPTION	DATE	CHECKED	APPROVED

INTERMITTENT FORCE @10% DUTY CYCLE	26.1 N	5.9 LB
CONTINUOUS FORCE	8.3 N	1.9 LB
FORCE CONSTANT	4.2 N/A	0.94 LB/A
BACK EMF CONSTANT	4.2 v/m/s	0.106 v/m/s
STROKE	25.4 mm	1.00 IN
COIL CLEARANCE PER SIDE	0.38 mm	0.015 IN
COIL ASSY MASS	38 GR	1.34 OZ
BODY MASS	184 GR	6.5 OZ
COIL RESISTANCE	4.1 Ohms	
COIL INDUCTANCE @120 Hz	1.9 mH	
MAX CONTINUOUS POWER	16.0 W	

ALL VALUES AT 25°C

NOTES :
UNLESS OTHERWISE SPECIFIED

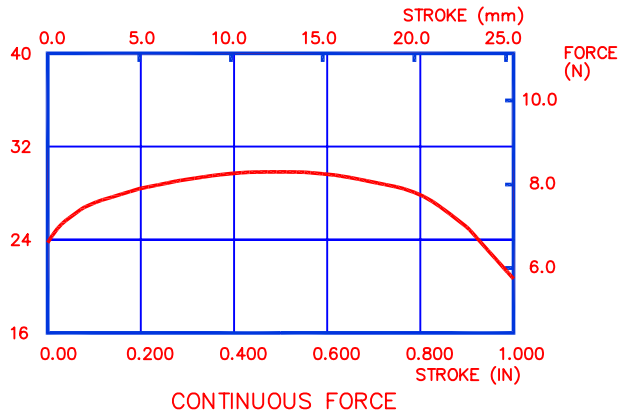

THIS DOCUMENT, WHETHER OR NOT MARKED AS PROPRIETARY, IS CONSIDERED CONFIDENTIAL AND SHALL REMAIN THE PROPERTY OF MOTICONT AND SHALL BE RETURNED TO MOTICONT UPON REQUEST WITH ALL COPIES MADE THEREOF. THIS DOCUMENT CANNOT BE UTILIZED IN THE MANUFACTURE OF ARTICLES SOLD OR OFFERED OR DISCLOSED TO ANYONE AND NO USE OF IT CAN BE MADE UNLESS EXPRESSLY AUTHORIZED BY AND UNDER THE DIRECTION OF MOTICONT. POSSESSION OF THIS DOCUMENT IS ACCEPTED SUBJECT TO THE FOREGOING.

DIMENSIONS ARE IN INCHES (mm) TOLERANCES ON:	
DECIMALS	FRACTIONS
.XXX .XX	± 1/125 ± 1/2"
± .005 ± .01 UNLESS OTHERWISE SPECIFIED	
USED ON	NEXT ASSY
APPLICATION	

MATERIAL	CONTRACT
FINISH TBD	DRN
	CHKD
	APPVD
	APPVD

MOTICONT			
LINEAR VOICE COIL MOTOR			
SIZE A	CODE	DWG. NO. LVCM-032-038-02	REV. 1
SCALE: 1 / 1		SHEET 1 OF 1	

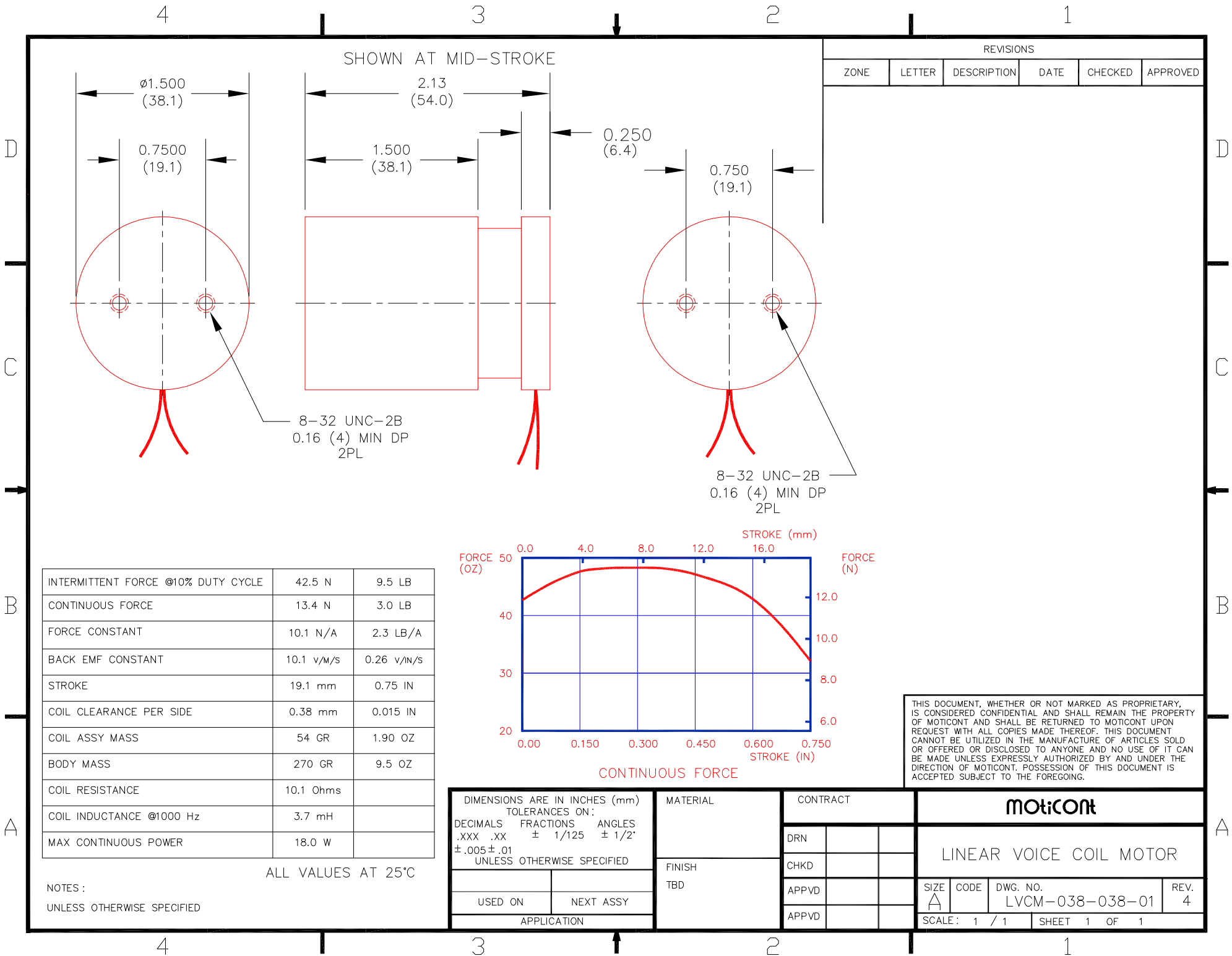

SHOWN AT MID-STROKE

REVISIONS

ZONE	LETTER	DESCRIPTION	DATE	CHECKED	APPROVED
------	--------	-------------	------	---------	----------

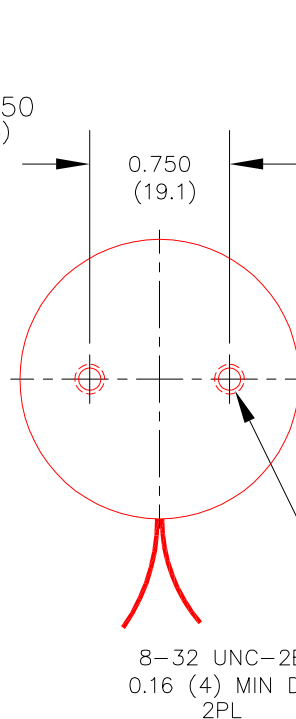
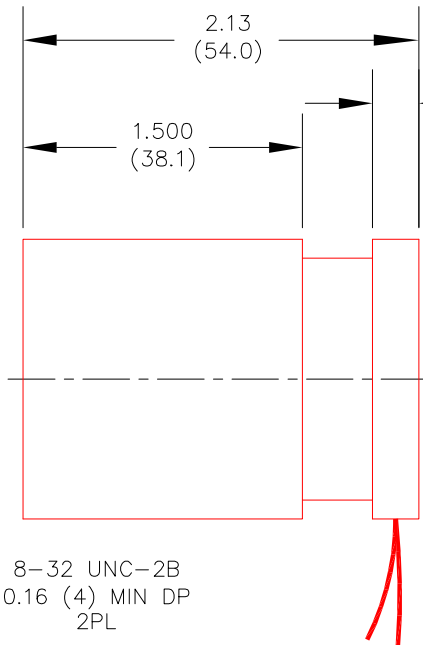
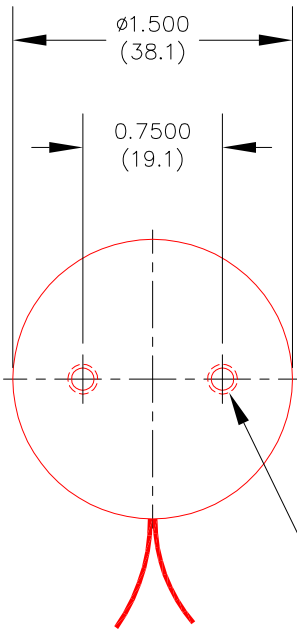

INTERMITTENT FORCE @10% DUTY CYCLE	42.5 N	9.5 LB
CONTINUOUS FORCE	13.4 N	3.0 LB
FORCE CONSTANT	10.1 N/A	2.3 LB/A
BACK EMF CONSTANT	10.1 v/m/s	0.26 v/in/s
STROKE	19.1 mm	0.75 IN
COIL CLEARANCE PER SIDE	0.38 mm	0.015 IN
COIL ASSY MASS	54 GR	1.90 OZ
BODY MASS	270 GR	9.5 OZ
COIL RESISTANCE	10.1 Ohms	
COIL INDUCTANCE @1000 Hz	3.7 mH	
MAX CONTINUOUS POWER	18.0 W	

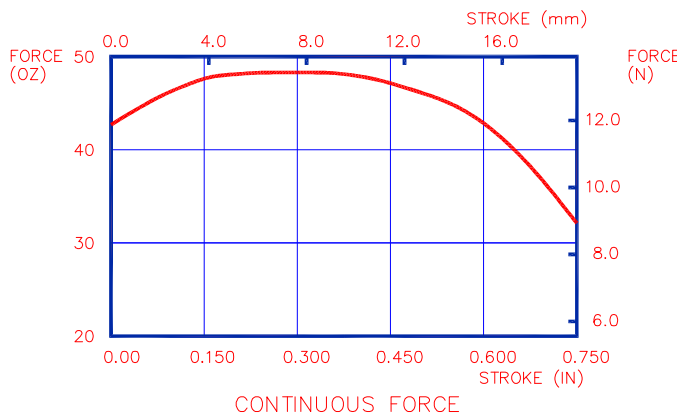

THIS DOCUMENT, WHETHER OR NOT MARKED AS PROPRIETARY, IS CONSIDERED CONFIDENTIAL AND SHALL REMAIN THE PROPERTY OF MOTICONT AND SHALL BE RETURNED TO MOTICONT UPON REQUEST WITH ALL COPIES MADE THEREOF. THIS DOCUMENT CANNOT BE UTILIZED IN THE MANUFACTURE OF ARTICLES SOLD OR OFFERED OR DISCLOSED TO ANYONE AND NO USE OF IT CAN BE MADE UNLESS EXPRESSLY AUTHORIZED BY AND UNDER THE DIRECTION OF MOTICONT. POSSESSION OF THIS DOCUMENT IS ACCEPTED SUBJECT TO THE FOREGOING.

ALL VALUES AT 25°C

NOTES :
UNLESS OTHERWISE SPECIFIED

DIMENSIONS ARE IN INCHES (mm) TOLERANCES ON: DECIMALS FRACTIONS ANGLES .XXX .XX ± 1/125 ± 1/2' ± .005 ± .01 UNLESS OTHERWISE SPECIFIED	
USED ON	NEXT ASSY
APPLICATION	

MATERIAL	CONTRACT
FINISH TBD	DRN
	CHKD
	APPVD
	APPVD

MOTICONT			
LINEAR VOICE COIL MOTOR			
SIZE A	CODE	DWG. NO. LVCM-038-038-01	REV. 4
SCALE: 1 / 1		SHEET 1 OF 1	

4

3

2

1

SHOWN AT MID-STROKE

REVISIONS					
ZONE	LETTER	DESCRIPTION	DATE	CHECKED	APPROVED

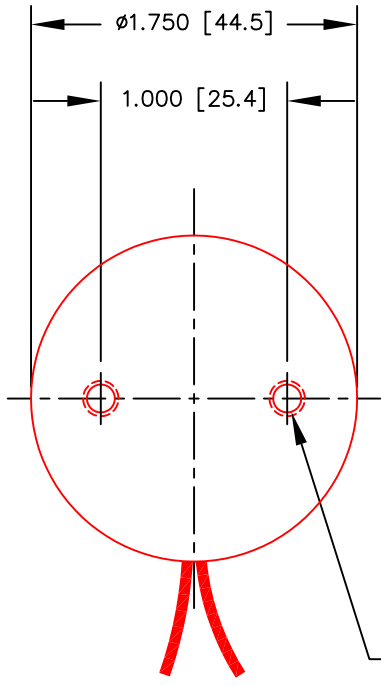

10-32 UNF-2B X 0.25 [6.4] DP (2)

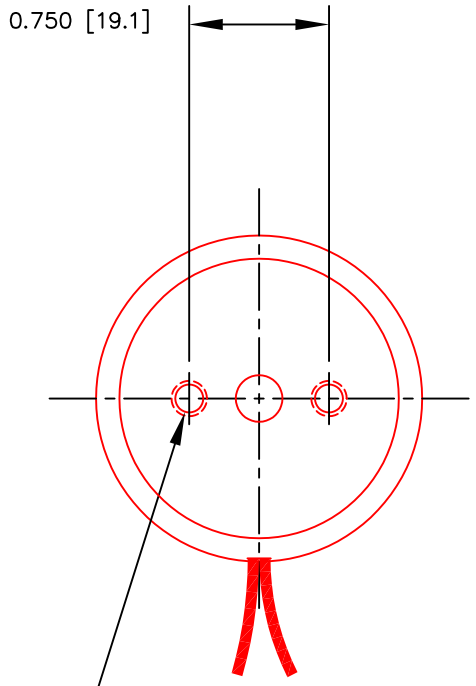
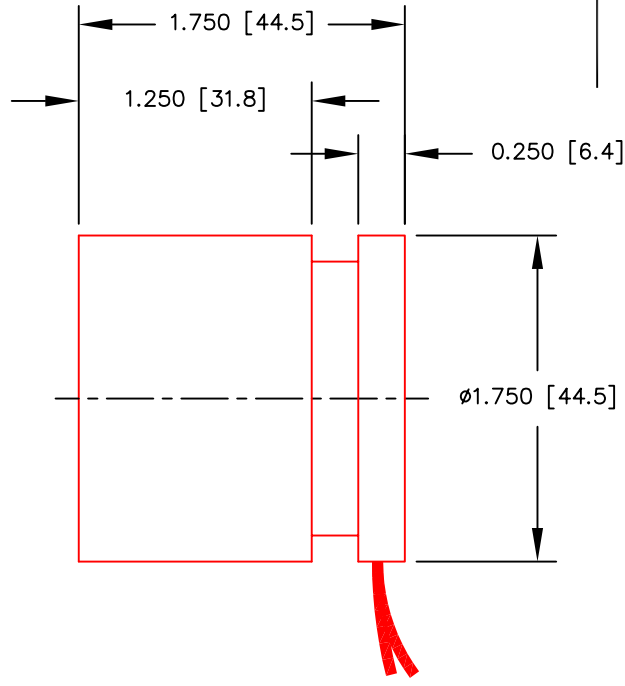

10-32 UNF-2B X 0.25 [6.4] DP (2)

INTERMITTENT FORCE @10% DUTY CYCLE	70.4 N	15.8 LB
CONTINUOUS FORCE	22.2 N	5.0 LB
FORCE CONSTANT	12.3 N/A	2.8 LB/A
BACK EMF CONSTANT	12.3 v/M/S	0.31 v/IN/S
STROKE	12.7 mm	0.50 IN
COIL CLEARANCE PER SIDE	0.38 mm	0.015 IN
COIL ASSY MASS	64 GR	2.3 OZ
BODY MASS	320 GR	11.3 OZ
COIL RESISTANCE	6.1 Ohms	
COIL INDUCTANCE @ 1000 Hz	3.8 mH	
MAX CONTINUOUS POWER	20.0 W	

ALL VALUES AT 25°C

UNLESS OTHERWISE SPECIFIED

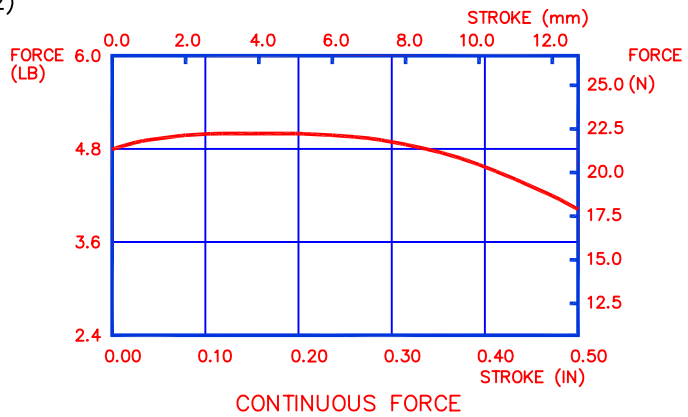

THIS DOCUMENT, WHETHER OR NOT MARKED AS PROPRIETARY, IS CONSIDERED CONFIDENTIAL AND SHALL REMAIN THE PROPERTY OF MOTICONT AND SHALL BE RETURNED TO MOTICONT UPON REQUEST WITH ALL COPIES MADE THEREOF. THIS DOCUMENT CANNOT BE UTILIZED IN THE MANUFACTURE OF ARTICLES SOLD OR OFFERED OR DISCLOSED TO ANYONE AND NO USE OF IT CAN BE MADE UNLESS EXPRESSLY AUTHORIZED BY AND UNDER THE DIRECTION OF MOTICONT. POSSESSION OF THIS DOCUMENT IS ACCEPTED SUBJECT TO THE FOREGOING.

DIMENSIONS ARE IN INCHES (mm) TOLERANCES ON: DECIMALS FRACTIONS ANGLES .XXX .XX ± 1/125 ± 1/2° ± .005 ± .01 UNLESS OTHERWISE SPECIFIED		MATERIAL	CONTRACT		motiCont LINEAR VOICE COIL MOTOR	
USED ON NEXT ASSY APPLICATION		FINISH	DRN	CHKD		
			APPVD		SIZE CODE DWG. NO. REV. A LVCM-044-032-02	
			APPVD		SCALE: 1 / 1 SHEET 1 OF 1	

4

3

2

1

D

C

B

A

D

C

B

A

4

3

2

1

SHOWN AT MID-STROKE

REVISIONS					
ZONE	LETTER	DESCRIPTION	DATE	CHECKED	APPROVED

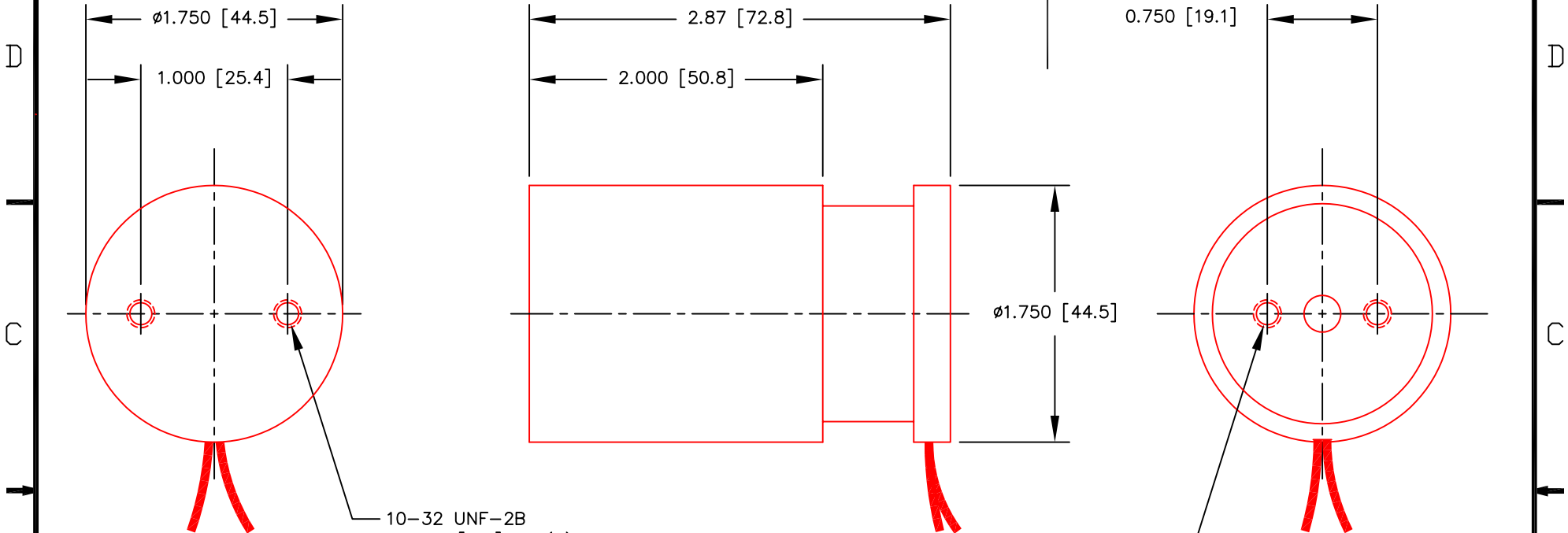

10-32 UNF-2B X 0.25 [6.4] DP (2)

10-32 UNF-2B X 0.25 [6.4] DP (2)

INTERMITTENT FORCE @10% DUTY CYCLE	68.4 N	15.4 LB
CONTINUOUS FORCE	21.6 N	4.9 LB
FORCE CONSTANT	10.3 N/A	2.3 LB/A
BACK EMF CONSTANT	10.3 v/M/s	0.26 v/N/s
STROKE	31.8 mm	1.25 IN
COIL CLEARANCE PER SIDE	0.38 mm	0.015 IN
COIL ASSY MASS	165 GR	5.8 OZ
BODY MASS	405 GR	14.3 OZ
COIL RESISTANCE	6.3 Ohms	
COIL INDUCTANCE @120 Hz	11.9 mH	
MAX CONTINUOUS POWER	28.0 W	

ALL VALUES AT 25°C

UNLESS OTHERWISE SPECIFIED

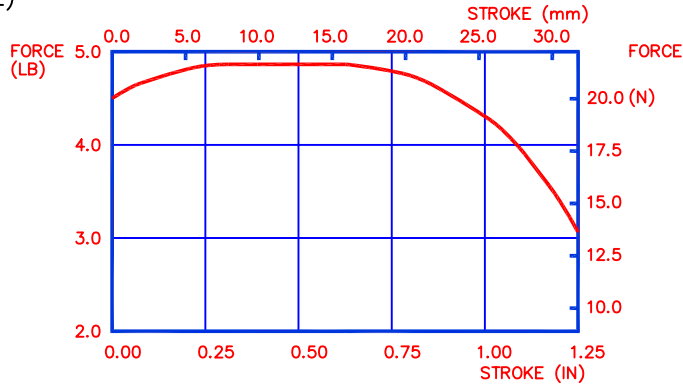

CONTINUOUS FORCE

THIS DOCUMENT, WHETHER OR NOT MARKED AS PROPRIETARY, IS CONSIDERED CONFIDENTIAL AND SHALL REMAIN THE PROPERTY OF MOTICONT AND SHALL BE RETURNED TO MOTICONT UPON REQUEST WITH ALL COPIES MADE THEREOF. THIS DOCUMENT CANNOT BE UTILIZED IN THE MANUFACTURE OF ARTICLES SOLD OR OFFERED OR DISCLOSED TO ANYONE AND NO USE OF IT CAN BE MADE UNLESS EXPRESSLY AUTHORIZED BY AND UNDER THE DIRECTION OF MOTICONT. POSSESSION OF THIS DOCUMENT IS ACCEPTED SUBJECT TO THE FOREGOING.

DIMENSIONS ARE IN INCHES (mm) TOLERANCES ON: DECIMALS FRACTIONS ANGLES .XXX .XX ± 1/125 ± 1/2° ± .005 ± .01 UNLESS OTHERWISE SPECIFIED		MATERIAL	CONTRACT		motiCont LINEAR VOICE COIL MOTOR		
USED ON		FINISH	DRN	CHKD			
NEXT ASSY			APPVD		DWG. NO. LVCM-044-051-01		REV. 2
APPLICATION			APPVD		SCALE: 1 / 1		SHEET 1 OF 1

4

3

2

1

SHOWN AT MID-STROKE

REVISIONS

ZONE	LETTER	DESCRIPTION	DATE	CHECKED	APPROVED

0.750 [19.1]

D

D

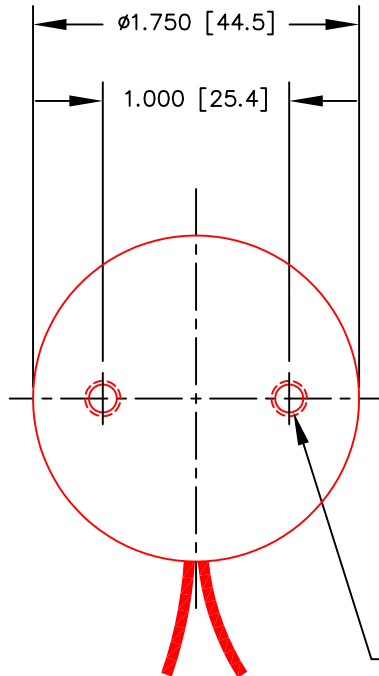
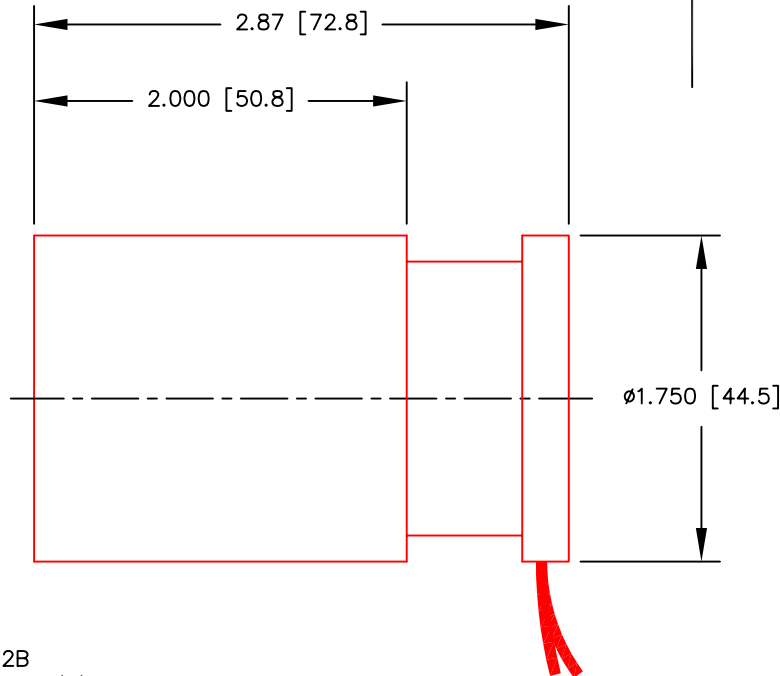
10-32 UNF-2B
X 0.25 [6.4] DP (2)

0.1750 [4.45]

C

C

B

B

INTERMITTENT FORCE @10% DUTY CYCLE	70.4 N	15.8 LB
CONTINUOUS FORCE	22.3 N	5.0 LB
FORCE CONSTANT	6.9 N/A	1.6 LB/A
BACK EMF CONSTANT	6.9 v/M/s	0.18 v/IN/s
STROKE	31.8 mm	1.25 IN
COIL CLEARANCE PER SIDE	0.38 mm	0.015 IN
COIL ASSY MASS	90 GR	3.2 OZ
BODY MASS	497 GR	17.5 OZ
COIL RESISTANCE	2.7 Ohms	
COIL INDUCTANCE @1000 Hz	1.4 mH	
MAX CONTINUOUS POWER	28.0 W	

ALL VALUES AT 25°C

UNLESS OTHERWISE SPECIFIED

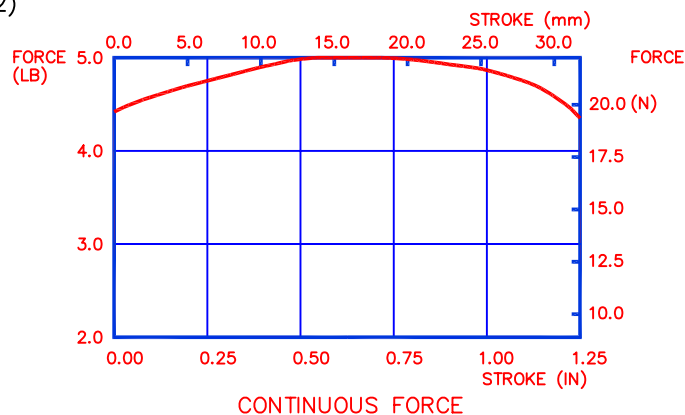

CONTINUOUS FORCE

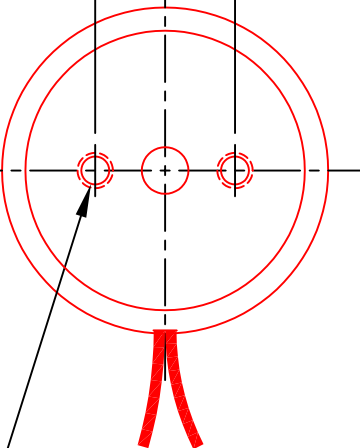
10-32 UNF-2B
X 0.25 [6.4] DP (2)

THIS DOCUMENT, WHETHER OR NOT MARKED AS PROPRIETARY, IS CONSIDERED CONFIDENTIAL AND SHALL REMAIN THE PROPERTY OF MOTICONT AND SHALL BE RETURNED TO MOTICONT UPON REQUEST WITH ALL COPIES MADE THEREOF. THIS DOCUMENT CANNOT BE UTILIZED IN THE MANUFACTURE OF ARTICLES SOLD OR OFFERED OR DISCLOSED TO ANYONE AND NO USE OF IT CAN BE MADE UNLESS EXPRESSLY AUTHORIZED BY AND UNDER THE DIRECTION OF MOTICONT. POSSESSION OF THIS DOCUMENT IS ACCEPTED SUBJECT TO THE FOREGOING.

A

A

DIMENSIONS ARE IN INCHES (mm)
TOLERANCES ON:
DECIMALS FRACTIONS ANGLES
.XXX .XX ± 1/125 ± 1/2°
± .005 ± .01
UNLESS OTHERWISE SPECIFIED

MATERIAL

CONTRACT

motiCont

USED ON	NEXT ASSY
APPLICATION	

FINISH

DRN

CHKD

APPVD

APPVD

LINEAR VOICE COIL MOTOR

SIZE

CODE

DWG. NO.

REV.

A

LVCM-044-051-02

1

SCALE: 1 / 1

SHEET 1 OF 1

4

3

2

1

4

3

2

1

SHOWN AT MID-STROKE

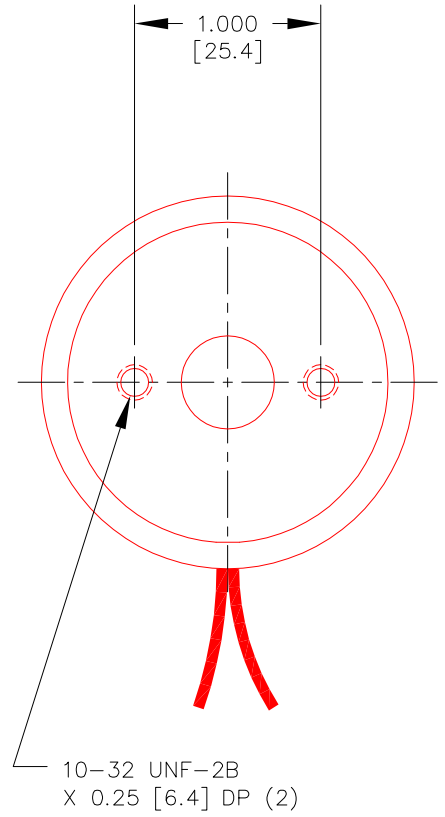
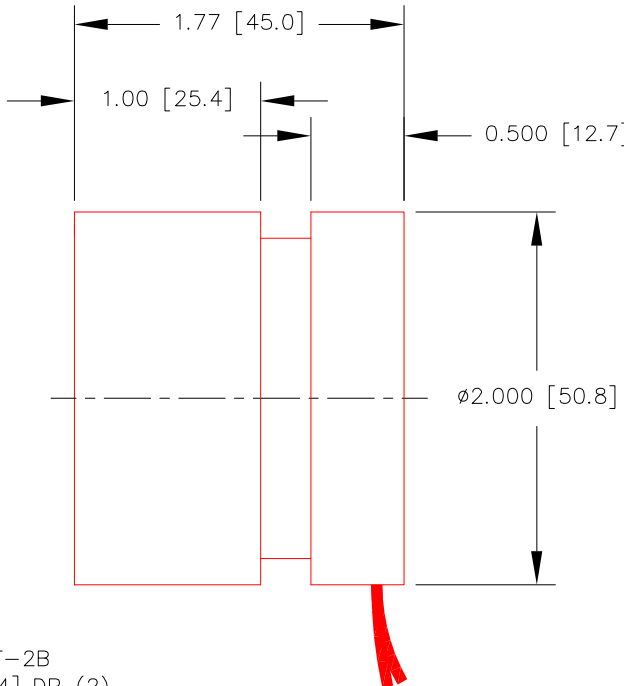
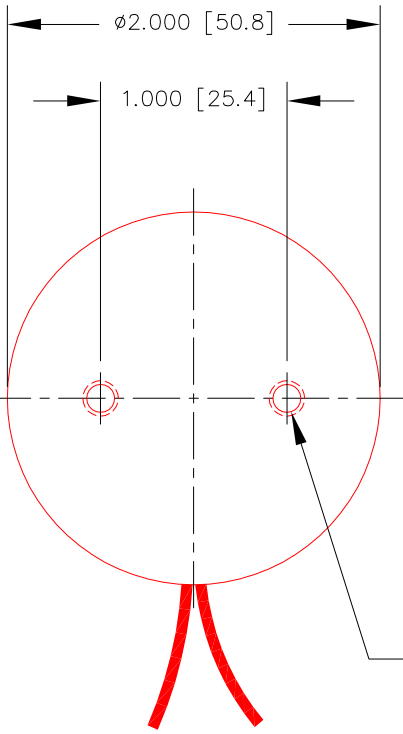

10-32 UNF-2B
X 0.25 [6.4] DP (2)

10-32 UNF-2B
X 0.25 [6.4] DP (2)

INTERMITTENT FORCE @10% DUTY CYCLE	74.8 N	16.9 LB
CONTINUOUS FORCE	23.7 N	5.3 LB
FORCE CONSTANT	6.9 N/A	1.6 LB/A
BACK EMF CONSTANT	6.9 V/M/S	0.18 V/IN/S
STROKE	12.7 mm	0.50 IN
COIL CLEARANCE PER SIDE	0.38 mm	0.015 IN
COIL ASSY MASS	92 GR	3.2 OZ
BODY MASS	326 GR	11.5 OZ
COIL RESISTANCE	1.7 Ohms	
COIL INDUCTANCE @ 1000 Hz	0.6 mH	
MAX CONTINUOUS POWER	20 W	

ALL VALUES AT 25°C

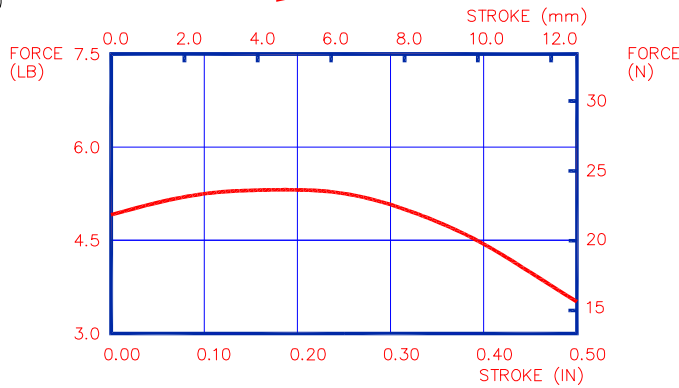

CONTINUOUS FORCE

THIS DOCUMENT, WHETHER OR NOT MARKED AS PROPRIETARY, IS CONSIDERED CONFIDENTIAL AND SHALL REMAIN THE PROPERTY OF MOTICONT AND SHALL BE RETURNED TO MOTICONT UPON REQUEST WITH ALL COPIES MADE THEREOF. THIS DOCUMENT CANNOT BE UTILIZED IN THE MANUFACTURE OF ARTICLES SOLD OR OFFERED OR DISCLOSED TO ANYONE AND NO USE OF IT CAN BE MADE UNLESS EXPRESSLY AUTHORIZED BY AND UNDER THE DIRECTION OF MOTICONT. POSSESSION OF THIS DOCUMENT IS ACCEPTED SUBJECT TO THE FOREGOING.

NOTES :
UNLESS OTHERWISE SPECIFIED

DIMENSIONS ARE IN INCHES (mm) TOLERANCES ON: DECIMALS FRACTIONS ANGLES .XXX .XX ± 1/125 ± 1/2' ± .005 ± .01 UNLESS OTHERWISE SPECIFIED		MATERIAL	CONTRACT						
USED ON		FINISH	DRN	CHKD				LINEAR VOICE COIL MOTOR	
NEXT ASSY		APPLICATION		APPVD	APPVD	SIZE	CODE	DWG. NO.	REV.
						A		LVCM-051-025-01	1
						SCALE: 1 / 1		SHEET 1 OF 1	

4

3

2

1

4

3

2

1

SHOWN AT MID-STROKE

REVISIONS					
ZONE	LETTER	DESCRIPTION	DATE	CHECKED	APPROVED

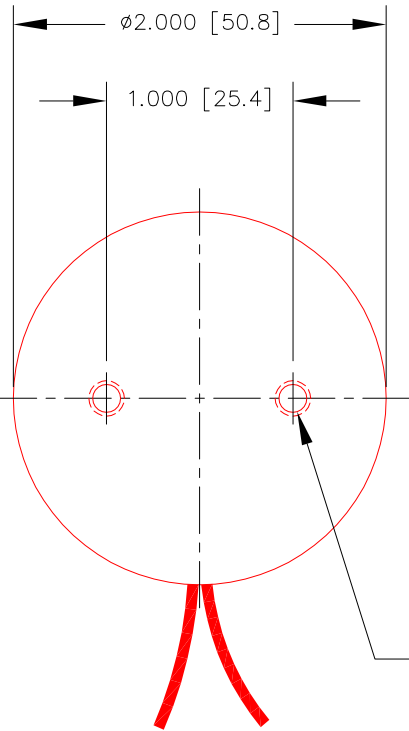

10-32 UNF-2B
X 0.25 [6.4] DP (2)

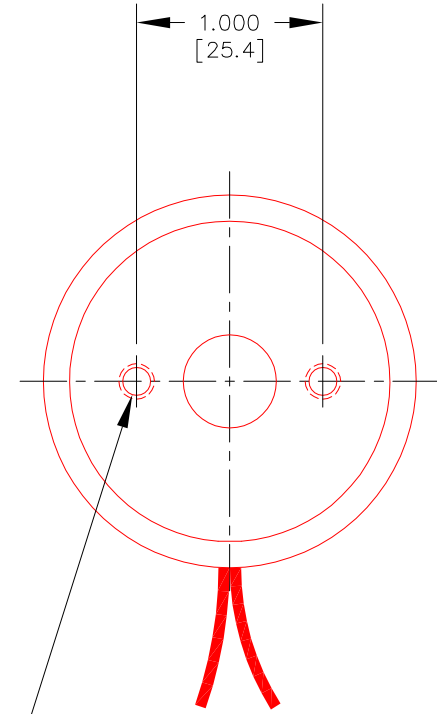
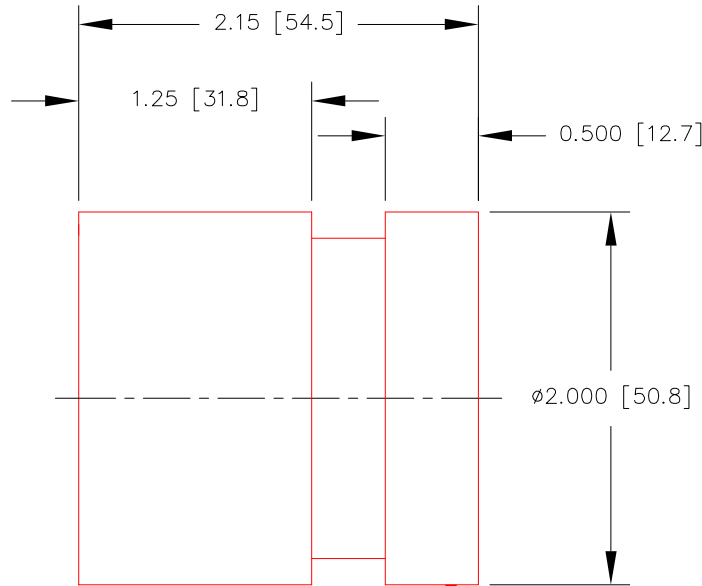

10-32 UNF-2B
X 0.25 [6.4] DP (2)

INTERMITTENT FORCE @10% DUTY CYCLE	89.9 N	20.0 LB
CONTINUOUS FORCE	28.2 N	6.3 LB
FORCE CONSTANT	8.4 N/A	1.9 LB/A
BACK EMF CONSTANT	8.4 V/M/S	0.21 V/IN/S
STROKE	19.1 mm	0.75 IN
COIL CLEARANCE PER SIDE	0.38 mm	0.015 IN
COIL ASSY MASS	103 GR	3.6 OZ
BODY MASS	409 GR	14.4 OZ
COIL RESISTANCE	2.2 Ohms	
COIL INDUCTANCE @ 1000 Hz	0.8 mH	
MAX CONTINUOUS POWER	25 W	

ALL VALUES AT 25°C

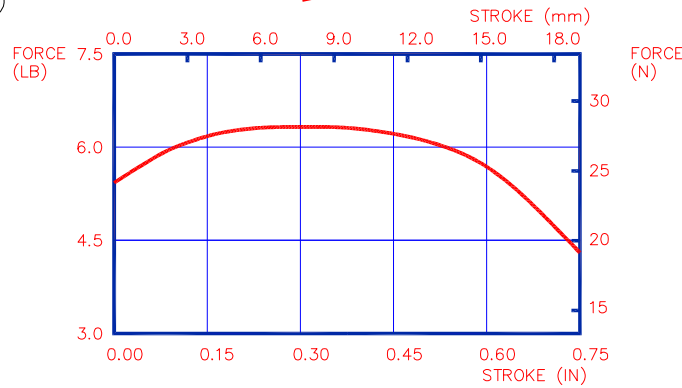

CONTINUOUS FORCE

THIS DOCUMENT, WHETHER OR NOT MARKED AS PROPRIETARY, IS CONSIDERED CONFIDENTIAL AND SHALL REMAIN THE PROPERTY OF MOTICONT AND SHALL BE RETURNED TO MOTICONT UPON REQUEST WITH ALL COPIES MADE THEREOF. THIS DOCUMENT CANNOT BE UTILIZED IN THE MANUFACTURE OF ARTICLES SOLD OR OFFERED OR DISCLOSED TO ANYONE AND NO USE OF IT CAN BE MADE UNLESS EXPRESSLY AUTHORIZED BY AND UNDER THE DIRECTION OF MOTICONT. POSSESSION OF THIS DOCUMENT IS ACCEPTED SUBJECT TO THE FOREGOING.

NOTES :
UNLESS OTHERWISE SPECIFIED

DIMENSIONS ARE IN INCHES (mm) TOLERANCES ON: DECIMALS FRACTIONS ANGLES .XXX .XX ± 1/125 ± 1/2' ± .005 ± .01 UNLESS OTHERWISE SPECIFIED	
USED ON	NEXT ASSY
APPLICATION	

MATERIAL	
FINISH	

CONTRACT	
DRN	
CHKD	
APPVD	
APPVD	

motiCont			
LINEAR VOICE COIL MOTOR			
SIZE A	CODE	DWG. NO. LVCM-051-032-01	REV. 1
SCALE: 1 / 1		SHEET 1 OF 1	

4

3

2

1

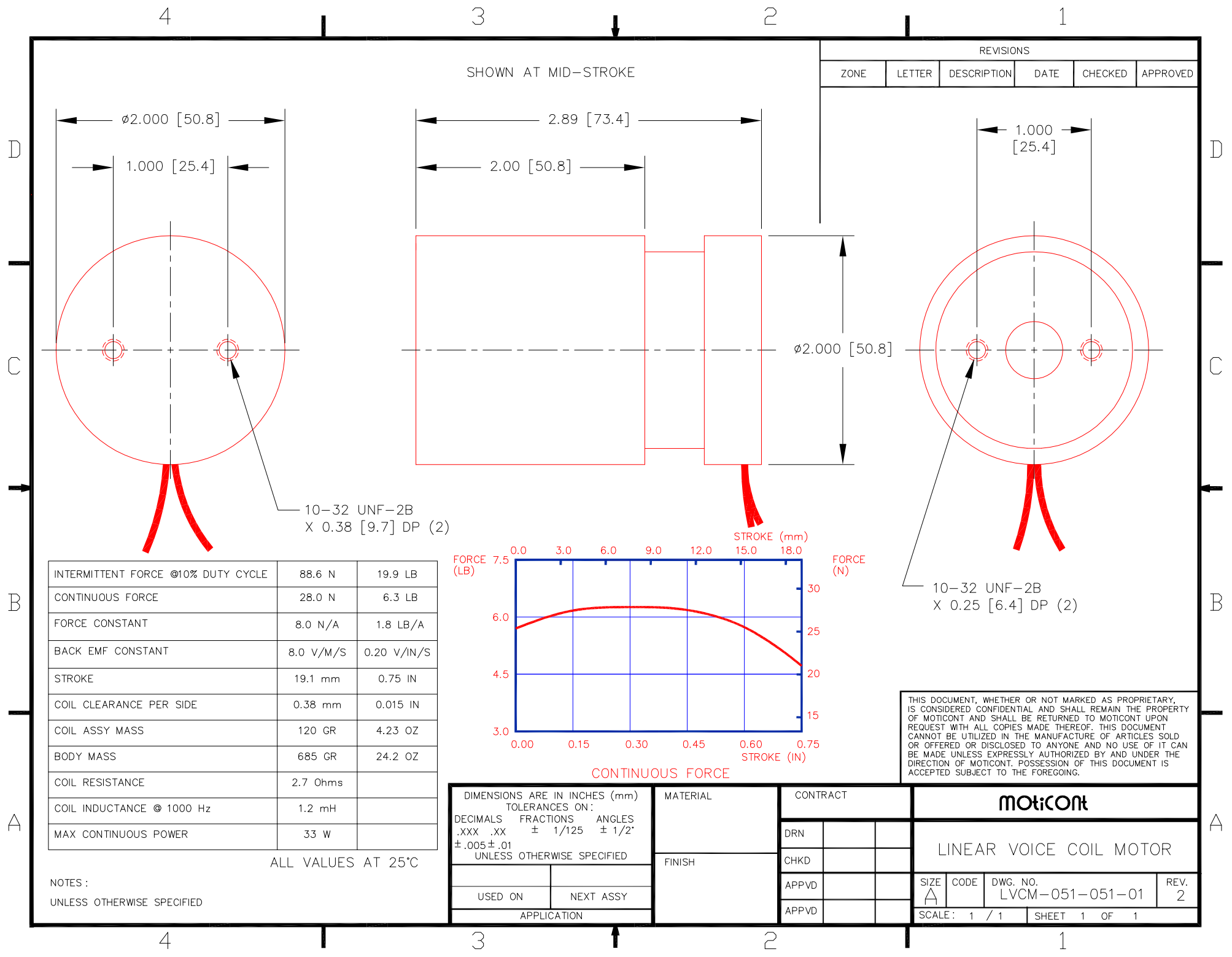

REVISIONS					
ZONE	LETTER	DESCRIPTION	DATE	CHECKED	APPROVED

SHOWN AT MID-STROKE

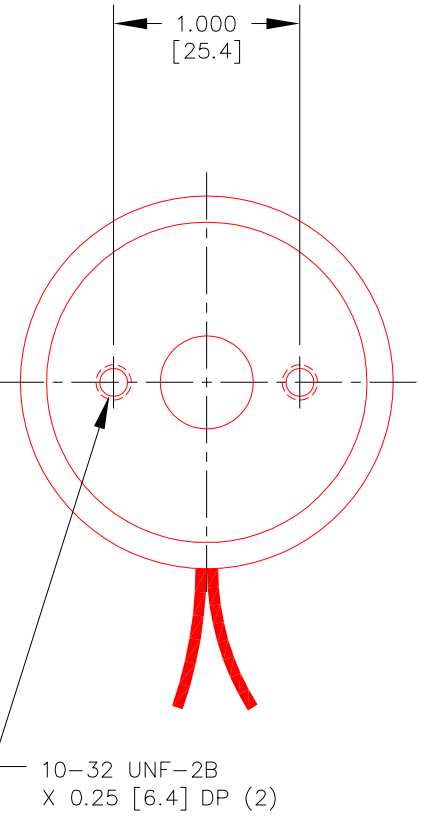
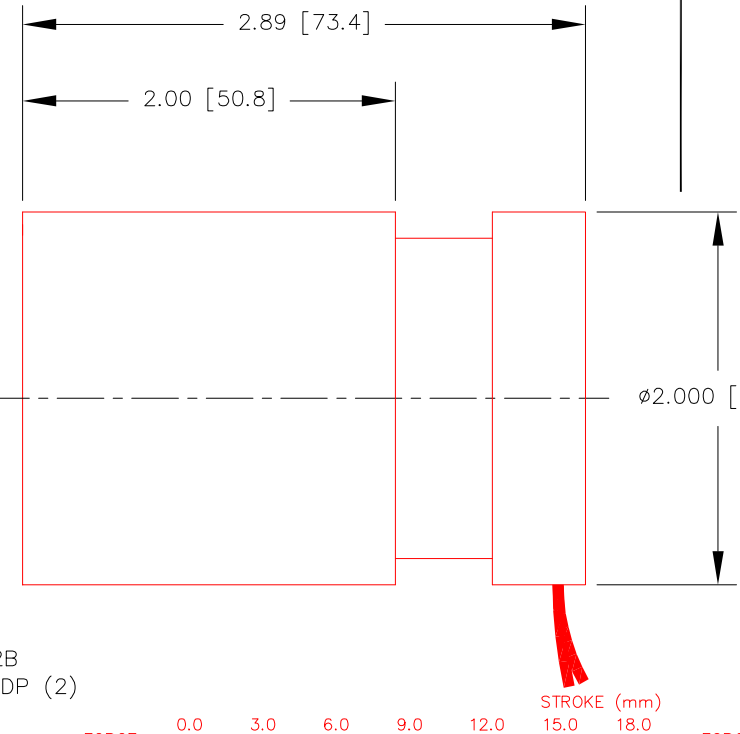
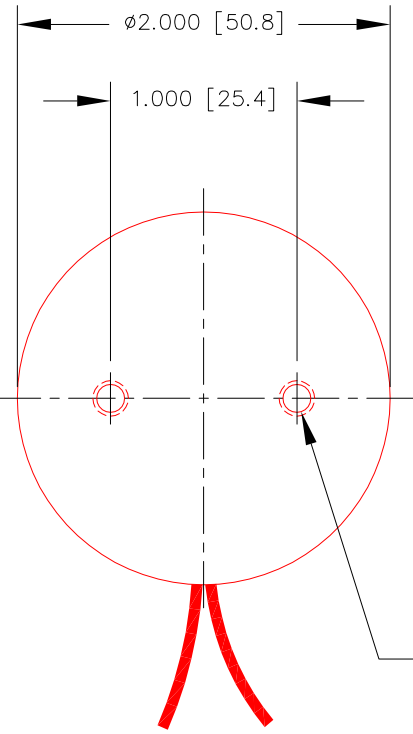

10-32 UNF-2B
X 0.38 [9.7] DP (2)

10-32 UNF-2B
X 0.25 [6.4] DP (2)

INTERMITTENT FORCE @10% DUTY CYCLE	88.6 N	19.9 LB
CONTINUOUS FORCE	28.0 N	6.3 LB
FORCE CONSTANT	8.0 N/A	1.8 LB/A
BACK EMF CONSTANT	8.0 V/M/S	0.20 V/IN/S
STROKE	19.1 mm	0.75 IN
COIL CLEARANCE PER SIDE	0.38 mm	0.015 IN
COIL ASSY MASS	120 GR	4.23 OZ
BODY MASS	685 GR	24.2 OZ
COIL RESISTANCE	2.7 Ohms	
COIL INDUCTANCE @ 1000 Hz	1.2 mH	
MAX CONTINUOUS POWER	33 W	

ALL VALUES AT 25°C

NOTES :
UNLESS OTHERWISE SPECIFIED

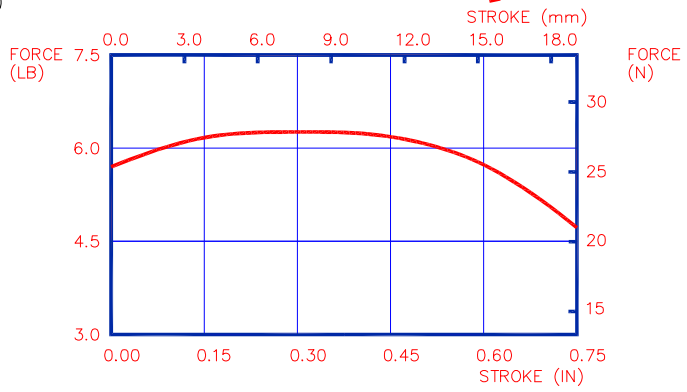

CONTINUOUS FORCE

THIS DOCUMENT, WHETHER OR NOT MARKED AS PROPRIETARY, IS CONSIDERED CONFIDENTIAL AND SHALL REMAIN THE PROPERTY OF MOTICONT AND SHALL BE RETURNED TO MOTICONT UPON REQUEST WITH ALL COPIES MADE THEREOF. THIS DOCUMENT CANNOT BE UTILIZED IN THE MANUFACTURE OF ARTICLES SOLD OR OFFERED OR DISCLOSED TO ANYONE AND NO USE OF IT CAN BE MADE UNLESS EXPRESSLY AUTHORIZED BY AND UNDER THE DIRECTION OF MOTICONT. POSSESSION OF THIS DOCUMENT IS ACCEPTED SUBJECT TO THE FOREGOING.

DIMENSIONS ARE IN INCHES (mm) TOLERANCES ON: DECIMALS FRACTIONS ANGLES .XXX .XX ± 1/125 ± 1/2' ± .005 ± .01 UNLESS OTHERWISE SPECIFIED		MATERIAL	CONTRACT		motiCont LINEAR VOICE COIL MOTOR			
USED ON		FINISH	DRN					
NEXT ASSY			CHKD		A		LVCM-051-051-01	2
APPLICATION			APPVD		SCALE: 1 / 1		SHEET 1 OF 1	

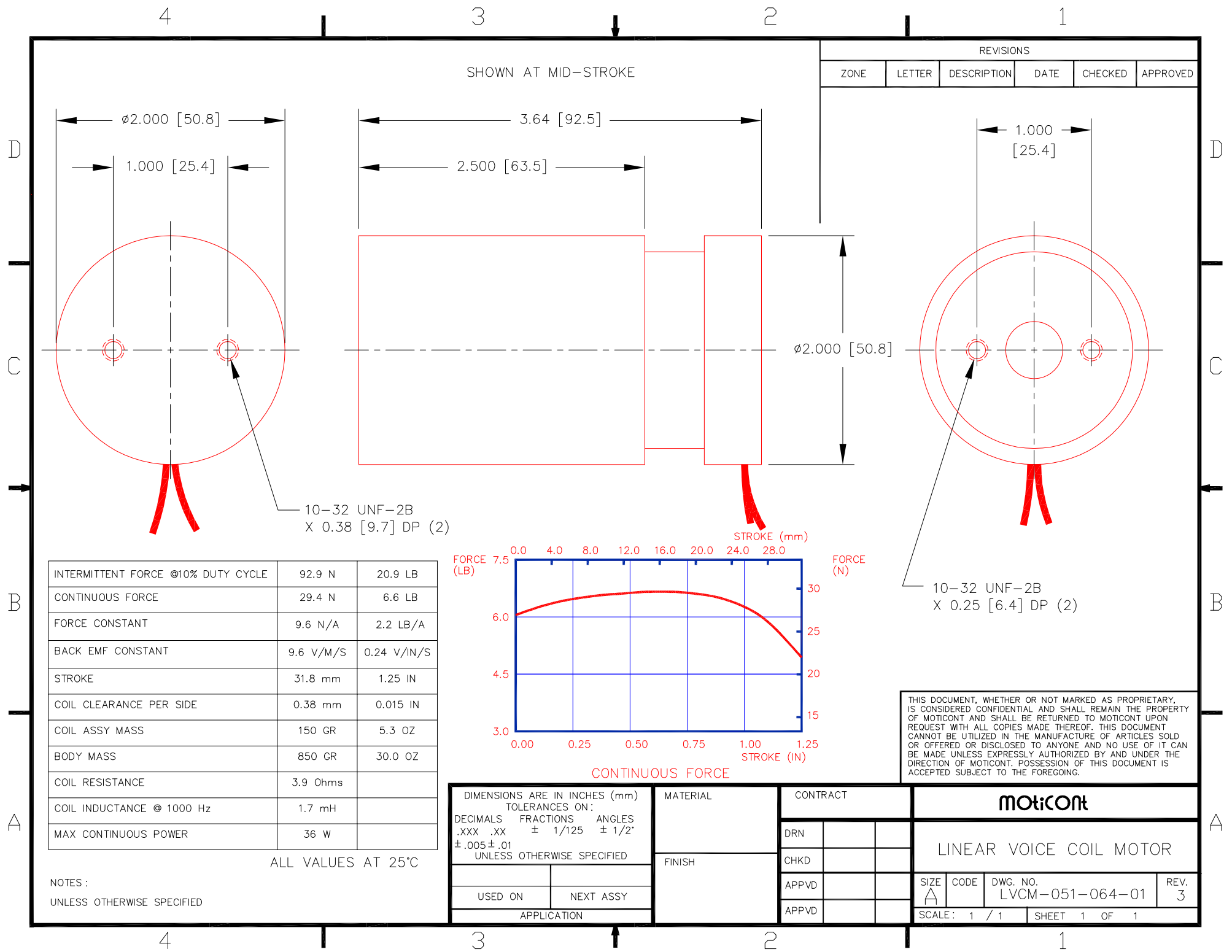

INTERMITTENT FORCE @10% DUTY CYCLE	92.9 N	20.9 LB
CONTINUOUS FORCE	29.4 N	6.6 LB
FORCE CONSTANT	9.6 N/A	2.2 LB/A
BACK EMF CONSTANT	9.6 V/M/S	0.24 V/IN/S
STROKE	31.8 mm	1.25 IN
COIL CLEARANCE PER SIDE	0.38 mm	0.015 IN
COIL ASSY MASS	150 GR	5.3 OZ
BODY MASS	850 GR	30.0 OZ
COIL RESISTANCE	3.9 Ohms	
COIL INDUCTANCE @ 1000 Hz	1.7 mH	
MAX CONTINUOUS POWER	36 W	

ALL VALUES AT 25°C

NOTES :
UNLESS OTHERWISE SPECIFIED

THIS DOCUMENT, WHETHER OR NOT MARKED AS PROPRIETARY, IS CONSIDERED CONFIDENTIAL AND SHALL REMAIN THE PROPERTY OF MOTICONT AND SHALL BE RETURNED TO MOTICONT UPON REQUEST WITH ALL COPIES MADE THEREOF. THIS DOCUMENT CANNOT BE UTILIZED IN THE MANUFACTURE OF ARTICLES SOLD OR OFFERED OR DISCLOSED TO ANYONE AND NO USE OF IT CAN BE MADE UNLESS EXPRESSLY AUTHORIZED BY AND UNDER THE DIRECTION OF MOTICONT. POSSESSION OF THIS DOCUMENT IS ACCEPTED SUBJECT TO THE FOREGOING.

DIMENSIONS ARE IN INCHES (mm) TOLERANCES ON: DECIMALS FRACTIONS ANGLES .XXX .XX ± 1/125 ± 1/2' ± .005 ± .01 UNLESS OTHERWISE SPECIFIED		MATERIAL	CONTRACT					
FINISH		DRN						LINEAR VOICE COIL MOTOR
USED ON		APPVD			SIZE	CODE	DWG. NO.	REV.
NEXT ASSY		APPVD			A		LVCM-051-064-01	3
APPLICATION		SCALE: 1 / 1		SHEET 1 OF 1				

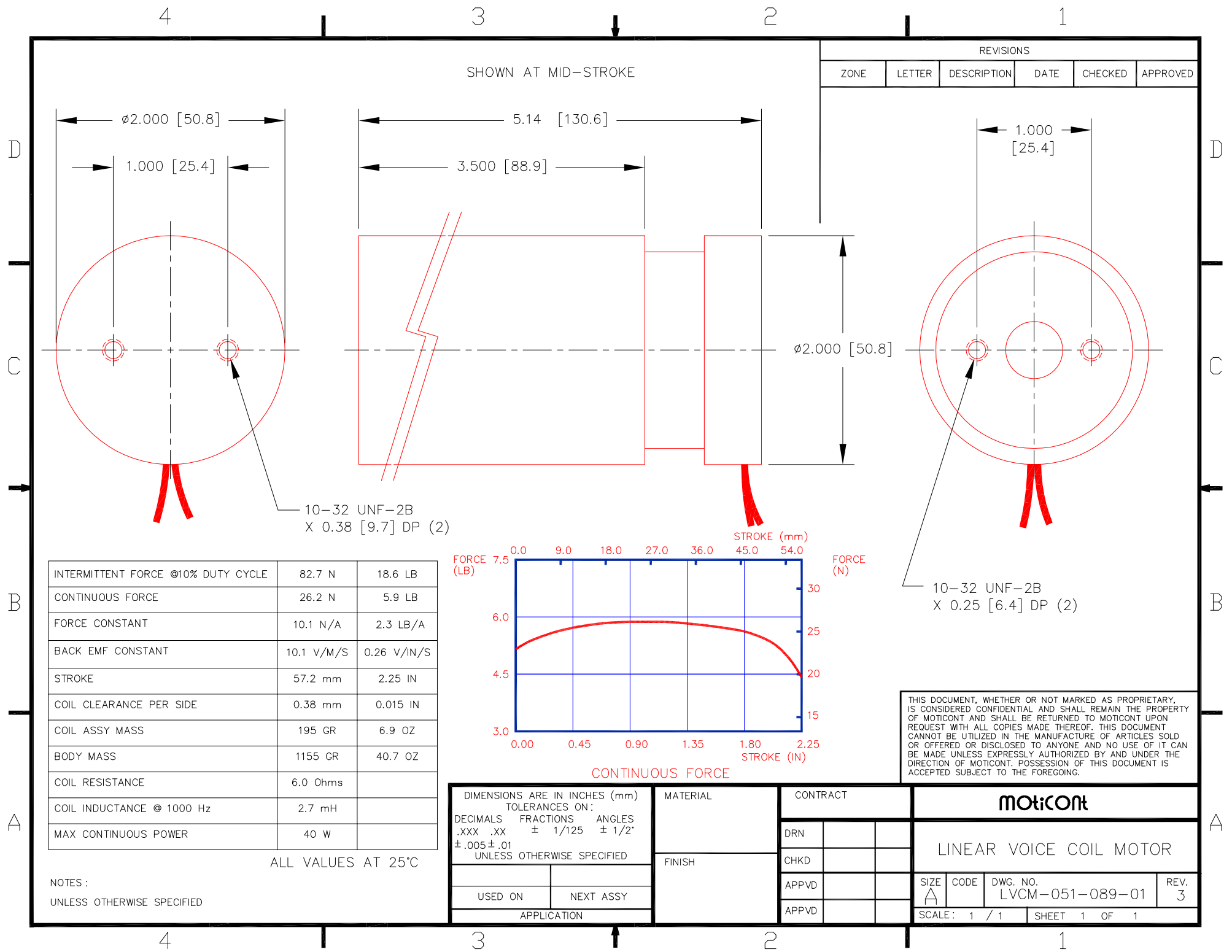

REVISIONS					
ZONE	LETTER	DESCRIPTION	DATE	CHECKED	APPROVED

INTERMITTENT FORCE @10% DUTY CYCLE	82.7 N	18.6 LB
CONTINUOUS FORCE	26.2 N	5.9 LB
FORCE CONSTANT	10.1 N/A	2.3 LB/A
BACK EMF CONSTANT	10.1 V/M/S	0.26 V/IN/S
STROKE	57.2 mm	2.25 IN
COIL CLEARANCE PER SIDE	0.38 mm	0.015 IN
COIL ASSY MASS	195 GR	6.9 OZ
BODY MASS	1155 GR	40.7 OZ
COIL RESISTANCE	6.0 Ohms	
COIL INDUCTANCE @ 1000 Hz	2.7 mH	
MAX CONTINUOUS POWER	40 W	

ALL VALUES AT 25°C

NOTES :
UNLESS OTHERWISE SPECIFIED

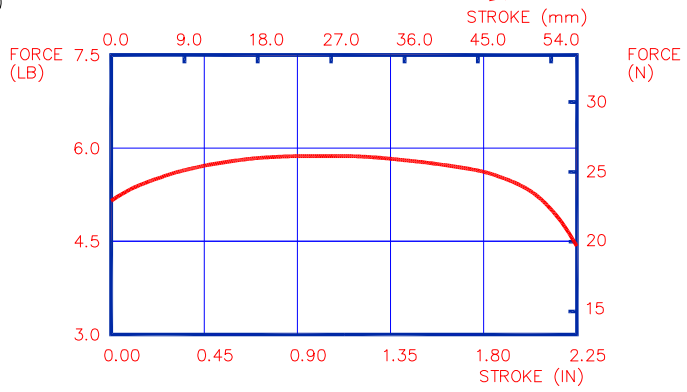

THIS DOCUMENT, WHETHER OR NOT MARKED AS PROPRIETARY, IS CONSIDERED CONFIDENTIAL AND SHALL REMAIN THE PROPERTY OF MOTICONT AND SHALL BE RETURNED TO MOTICONT UPON REQUEST WITH ALL COPIES MADE THEREOF. THIS DOCUMENT CANNOT BE UTILIZED IN THE MANUFACTURE OF ARTICLES SOLD OR OFFERED OR DISCLOSED TO ANYONE AND NO USE OF IT CAN BE MADE UNLESS EXPRESSLY AUTHORIZED BY AND UNDER THE DIRECTION OF MOTICONT. POSSESSION OF THIS DOCUMENT IS ACCEPTED SUBJECT TO THE FOREGOING.

DIMENSIONS ARE IN INCHES (mm) TOLERANCES ON: DECIMALS FRACTIONS ANGLES .XXX .XX ± 1/125 ± 1/2' ± .005 ± .01 UNLESS OTHERWISE SPECIFIED		MATERIAL	CONTRACT				
FINISH		DRN		LINEAR VOICE COIL MOTOR			
USED ON		CHKD		SIZE	CODE	DWG. NO.	REV.
NEXT ASSY		APPVD		A		LVCM-051-089-01	3
APPLICATION		APPVD		SCALE: 1 / 1		SHEET 1 OF 1	

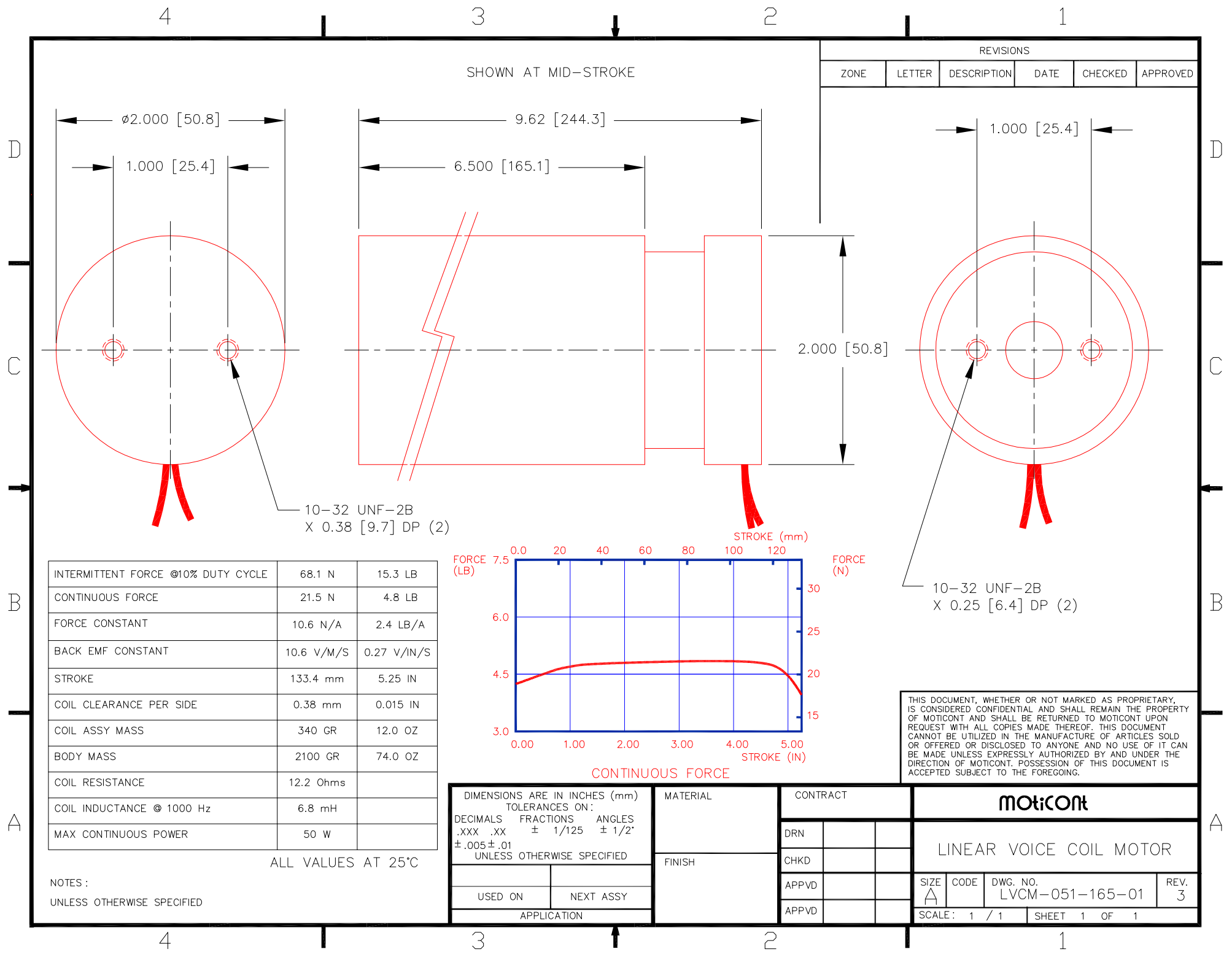

REVISIONS					
ZONE	LETTER	DESCRIPTION	DATE	CHECKED	APPROVED

INTERMITTENT FORCE @10% DUTY CYCLE	68.1 N	15.3 LB
CONTINUOUS FORCE	21.5 N	4.8 LB
FORCE CONSTANT	10.6 N/A	2.4 LB/A
BACK EMF CONSTANT	10.6 V/M/S	0.27 V/IN/S
STROKE	133.4 mm	5.25 IN
COIL CLEARANCE PER SIDE	0.38 mm	0.015 IN
COIL ASSY MASS	340 GR	12.0 OZ
BODY MASS	2100 GR	74.0 OZ
COIL RESISTANCE	12.2 Ohms	
COIL INDUCTANCE @ 1000 Hz	6.8 mH	
MAX CONTINUOUS POWER	50 W	

ALL VALUES AT 25°C

NOTES :
UNLESS OTHERWISE SPECIFIED

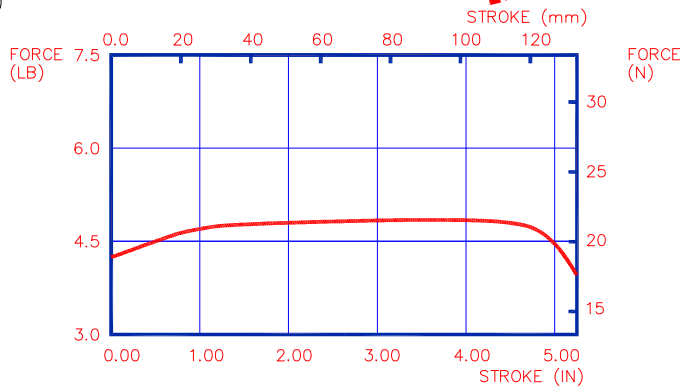

CONTINUOUS FORCE

THIS DOCUMENT, WHETHER OR NOT MARKED AS PROPRIETARY, IS CONSIDERED CONFIDENTIAL AND SHALL REMAIN THE PROPERTY OF MOTICONT AND SHALL BE RETURNED TO MOTICONT UPON REQUEST WITH ALL COPIES MADE THEREOF. THIS DOCUMENT CANNOT BE UTILIZED IN THE MANUFACTURE OF ARTICLES SOLD OR OFFERED OR DISCLOSED TO ANYONE AND NO USE OF IT CAN BE MADE UNLESS EXPRESSLY AUTHORIZED BY AND UNDER THE DIRECTION OF MOTICONT. POSSESSION OF THIS DOCUMENT IS ACCEPTED SUBJECT TO THE FOREGOING.

DIMENSIONS ARE IN INCHES (mm) TOLERANCES ON: DECIMALS FRACTIONS ANGLES .XXX .XX ± 1/125 ± 1/2' ± .005 ± .01 UNLESS OTHERWISE SPECIFIED		MATERIAL	CONTRACT				
FINISH		DRN					
USED ON		CHKD			LINEAR VOICE COIL MOTOR SIZE CODE DWG. NO. REV. A LVCM-051-165-01 3		
NEXT ASSY		APPVD					
APPLICATION		APPVD			SCALE: 1 / 1 SHEET 1 OF 1		

4 3 2 1

SHOWN AT MID-STROKE

REVISIONS					
ZONE	LETTER	DESCRIPTION	DATE	CHECKED	APPROVED

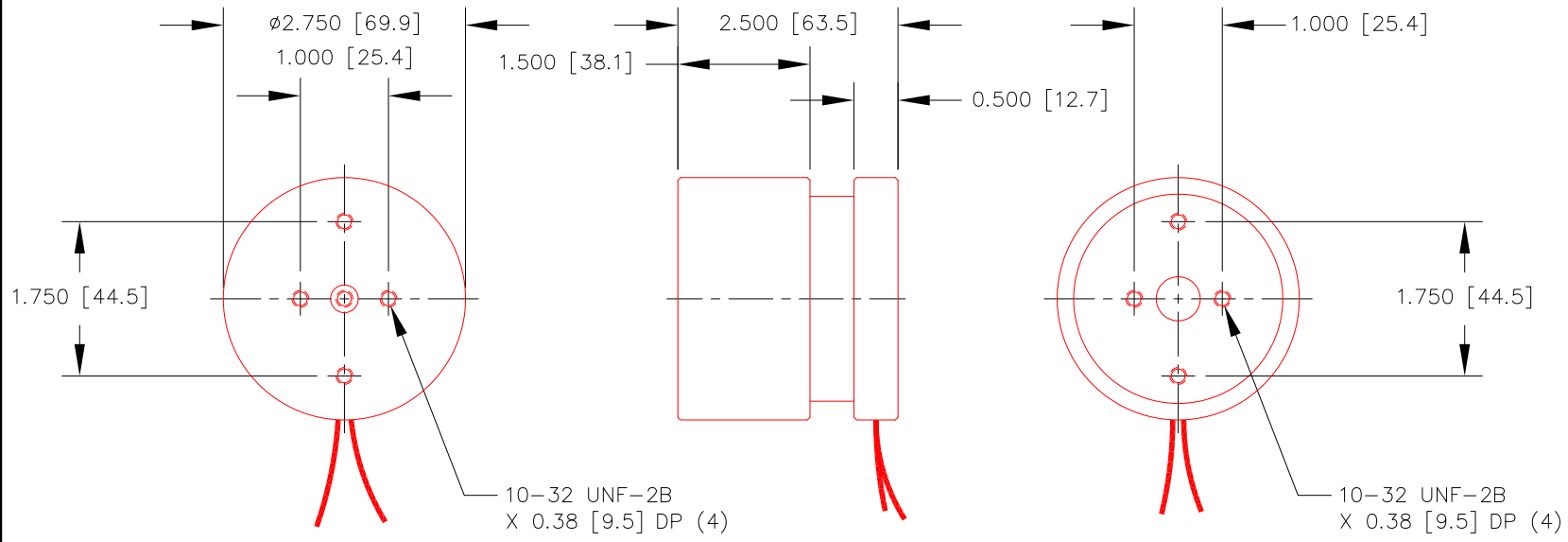

INTERMITTENT FORCE @10% DUTY CYCLE	204.4 N	45.9 LB
CONTINUOUS FORCE	64.6 N	14.5 LB
FORCE CONSTANT	21.2 N/A	4.7 LB/A
BACK EMF CONSTANT	21.2 V/M/S	0.54 V/IN/S
STROKE	12.7 mm	0.50 IN
COIL CLEARANCE PER SIDE	0.64 mm	0.025 IN
COIL ASSY MASS	192 GR	0.42 LB
BODY MASS	0.95 KG	2.10 LB
COIL RESISTANCE	4.3 Ohms	
COIL INDUCTANCE @ 1000 Hz	2.4 mH	
MAX CONTINUOUS POWER	40 W	

ALL VALUES AT 25°C

NOTES :
UNLESS OTHERWISE SPECIFIED

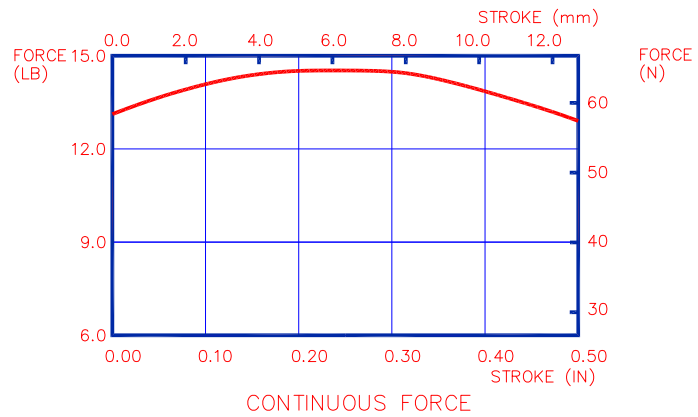

THIS DOCUMENT, WHETHER OR NOT MARKED AS PROPRIETARY, IS CONSIDERED CONFIDENTIAL AND SHALL REMAIN THE PROPERTY OF MOTICONT AND SHALL BE RETURNED TO MOTICONT UPON REQUEST WITH ALL COPIES MADE THEREOF. THIS DOCUMENT CANNOT BE UTILIZED IN THE MANUFACTURE OF ARTICLES SOLD OR OFFERED OR DISCLOSED TO ANYONE AND NO USE OF IT CAN BE MADE UNLESS EXPRESSLY AUTHORIZED BY AND UNDER THE DIRECTION OF MOTICONT. POSSESSION OF THIS DOCUMENT IS ACCEPTED SUBJECT TO THE FOREGOING.

DIMENSIONS ARE IN INCHES (mm) TOLERANCES ON: DECIMALS FRACTIONS ANGLES .XXX .XX ± 1/125 ± 1/2° ± .005 ± .01 UNLESS OTHERWISE SPECIFIED		MATERIAL	CONTRACT					
FINISH		DRN						
USED ON		CHKD			LINEAR VOICE COIL MOTOR			
NEXT ASSY		APPVD			SIZE	CODE	DWG. NO.	REV.
APPLICATION		APPVD			A		LVCM-070-038-01	1
				SCALE: 1 / 2		SHEET 1 OF 1		

4 3 2 1

REVISIONS					
ZONE	LETTER	DESCRIPTION	DATE	CHECKED	APPROVED

SHOWN AT MID-STROKE

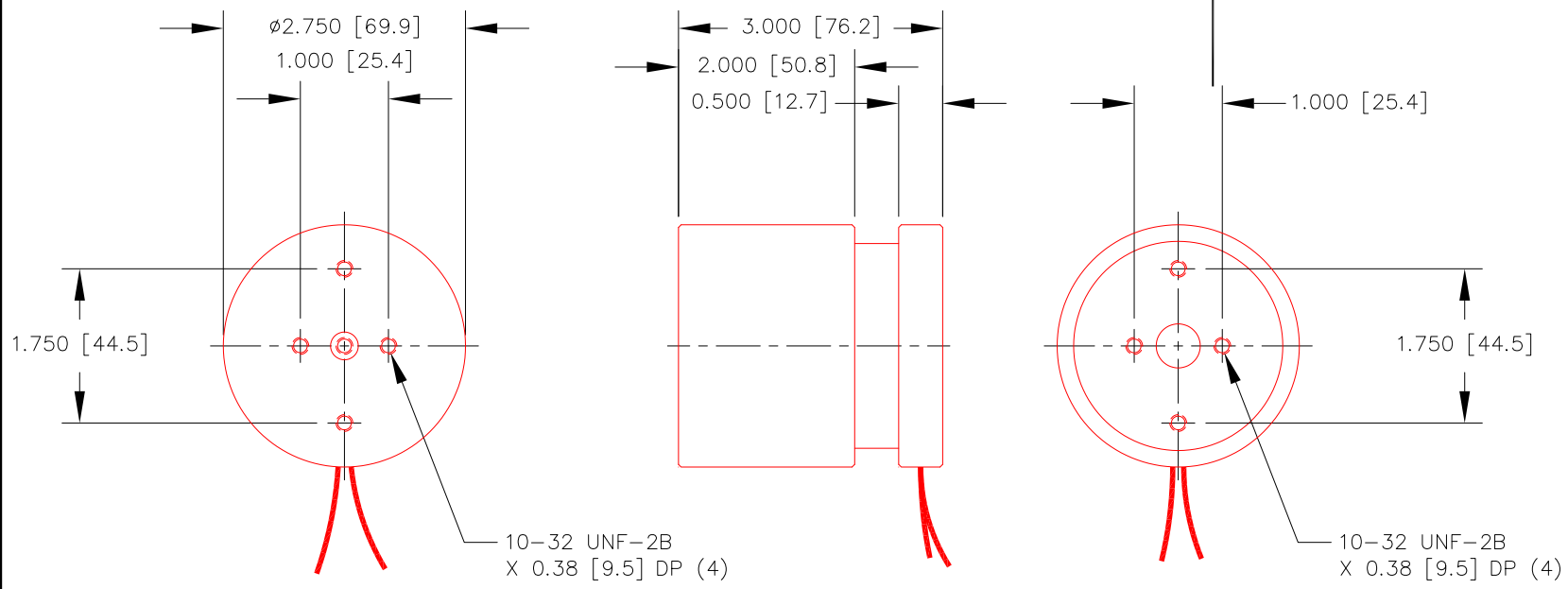

INTERMITTENT FORCE @10% DUTY CYCLE	204.3 N	46.0 LB
CONTINUOUS FORCE	64.7 N	14.6 LB
FORCE CONSTANT	24.4 N/A	5.5 LB/A
BACK EMF CONSTANT	24.4 V/M/S	0.62 V/IN/S
STROKE	25.4 mm	1.00 IN
COIL CLEARANCE PER SIDE	0.64 mm	0.025 IN
COIL ASSY MASS	240 GR	0.53 LB
BODY MASS	1.24 KG	2.74 LB
COIL RESISTANCE	6.4 Ohms	
COIL INDUCTANCE @ 1000 Hz	4.0 mH	
MAX CONTINUOUS POWER	45 W	

ALL VALUES AT 25°C

NOTES :
UNLESS OTHERWISE SPECIFIED

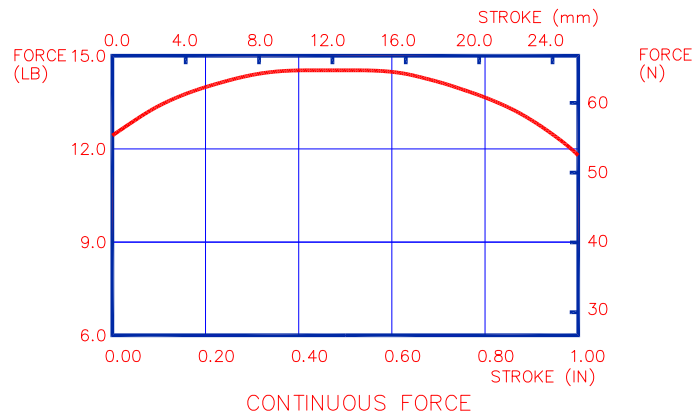

THIS DOCUMENT, WHETHER OR NOT MARKED AS PROPRIETARY, IS CONSIDERED CONFIDENTIAL AND SHALL REMAIN THE PROPERTY OF MOTICONT AND SHALL BE RETURNED TO MOTICONT UPON REQUEST WITH ALL COPIES MADE THEREOF. THIS DOCUMENT CANNOT BE UTILIZED IN THE MANUFACTURE OF ARTICLES SOLD OR OFFERED OR DISCLOSED TO ANYONE AND NO USE OF IT CAN BE MADE UNLESS EXPRESSLY AUTHORIZED BY AND UNDER THE DIRECTION OF MOTICONT. POSSESSION OF THIS DOCUMENT IS ACCEPTED SUBJECT TO THE FOREGOING.

DIMENSIONS ARE IN INCHES (mm) TOLERANCES ON: DECIMALS FRACTIONS ANGLES .XXX .XX ± 1/125 ± 1/2° ± .005 ± .01 UNLESS OTHERWISE SPECIFIED		MATERIAL	CONTRACT				
FINISH		DRN					
USED ON		CHKD			LINEAR VOICE COIL MOTOR SIZE CODE DWG. NO. REV. A 1 LVCM-070-051-01 1		
NEXT ASSY		APPVD					
APPLICATION		APPVD			SCALE: 1 / 2 SHEET 1 OF 1		

B A

4 3 2 1

4 3 2 1

REVISIONS					
ZONE	LETTER	DESCRIPTION	DATE	CHECKED	APPROVED

SHOWN AT MID-STROKE

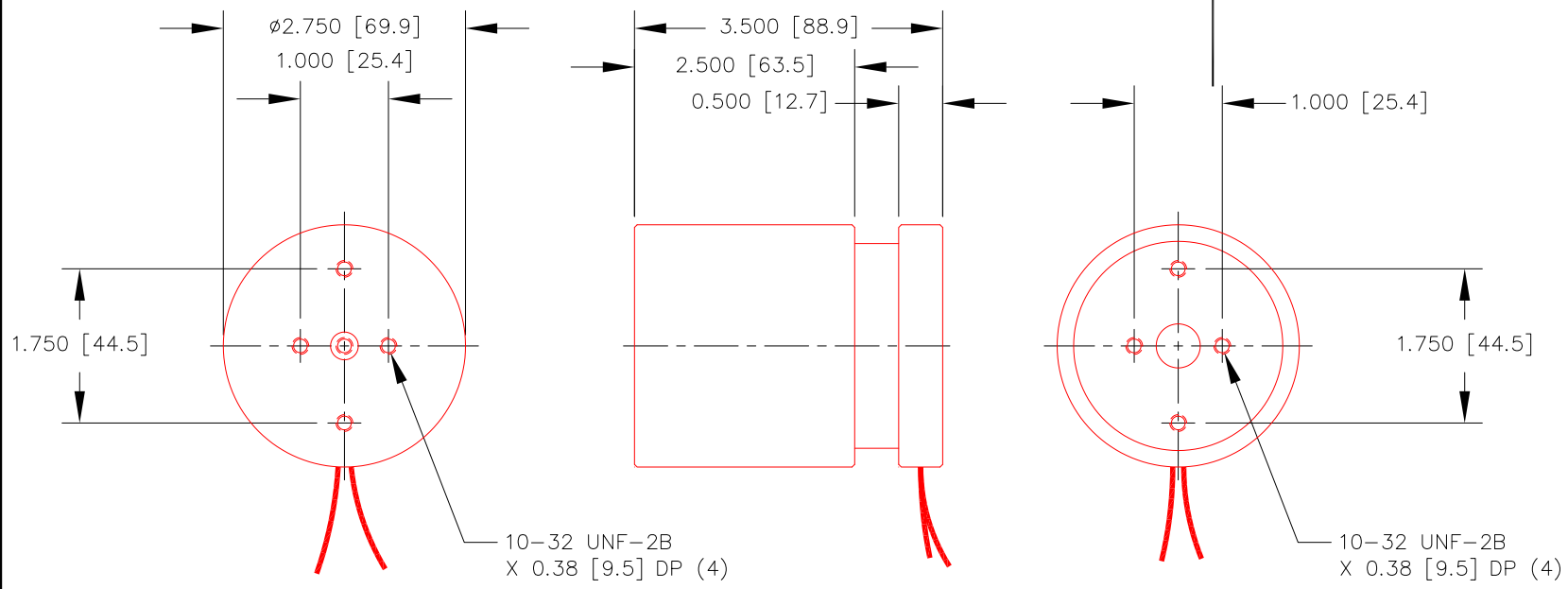

INTERMITTENT FORCE @10% DUTY CYCLE	202.1 N	45.5 LB
CONTINUOUS FORCE	64.0 N	14.4 LB
FORCE CONSTANT	11.0 N/A	2.5 LB/A
BACK EMF CONSTANT	11.0 V/M/S	0.28 V/IN/S
STROKE	38.1 mm	1.50 IN
COIL CLEARANCE PER SIDE	0.64 mm	0.025 IN
COIL ASSY MASS	305 GR	0.67 LB
BODY MASS	1.53 KG	3.37 LB
COIL RESISTANCE	1.5 Ohms	
COIL INDUCTANCE @ 1000 Hz	1.0 mH	
MAX CONTINUOUS POWER	50 W	

ALL VALUES AT 25°C

NOTES :
UNLESS OTHERWISE SPECIFIED

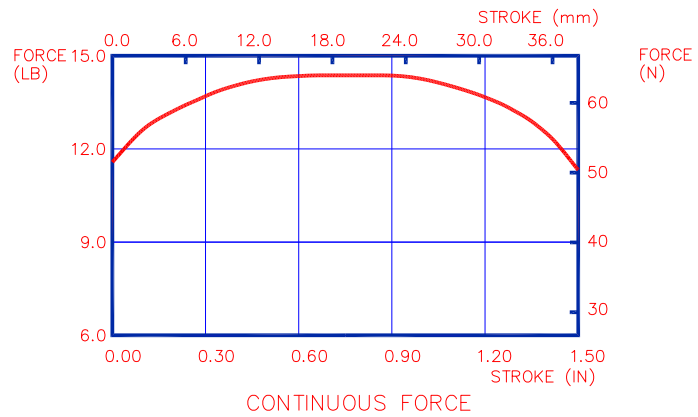

THIS DOCUMENT, WHETHER OR NOT MARKED AS PROPRIETARY, IS CONSIDERED CONFIDENTIAL AND SHALL REMAIN THE PROPERTY OF MOTICONT AND SHALL BE RETURNED TO MOTICONT UPON REQUEST WITH ALL COPIES MADE THEREOF. THIS DOCUMENT CANNOT BE UTILIZED IN THE MANUFACTURE OF ARTICLES SOLD OR OFFERED OR DISCLOSED TO ANYONE AND NO USE OF IT CAN BE MADE UNLESS EXPRESSLY AUTHORIZED BY AND UNDER THE DIRECTION OF MOTICONT. POSSESSION OF THIS DOCUMENT IS ACCEPTED SUBJECT TO THE FOREGOING.

DIMENSIONS ARE IN INCHES (mm) TOLERANCES ON: DECIMALS FRACTIONS ANGLES .XXX .XX ± 1/125 ± 1/2° ± .005 ± .01 UNLESS OTHERWISE SPECIFIED		MATERIAL	CONTRACT					
FINISH		DRN						
USED ON		CHKD			LINEAR VOICE COIL MOTOR			
NEXT ASSY		APPVD						
APPLICATION		APPVD			SIZE	CODE	DWG. NO.	REV.
					A		LVCM-070-064-01	1
					SCALE: 1 / 2		SHEET 1 OF 1	

4 3 2 1

4 3 2 1

SHOWN AT MID-STROKE

REVISIONS					
ZONE	LETTER	DESCRIPTION	DATE	CHECKED	APPROVED

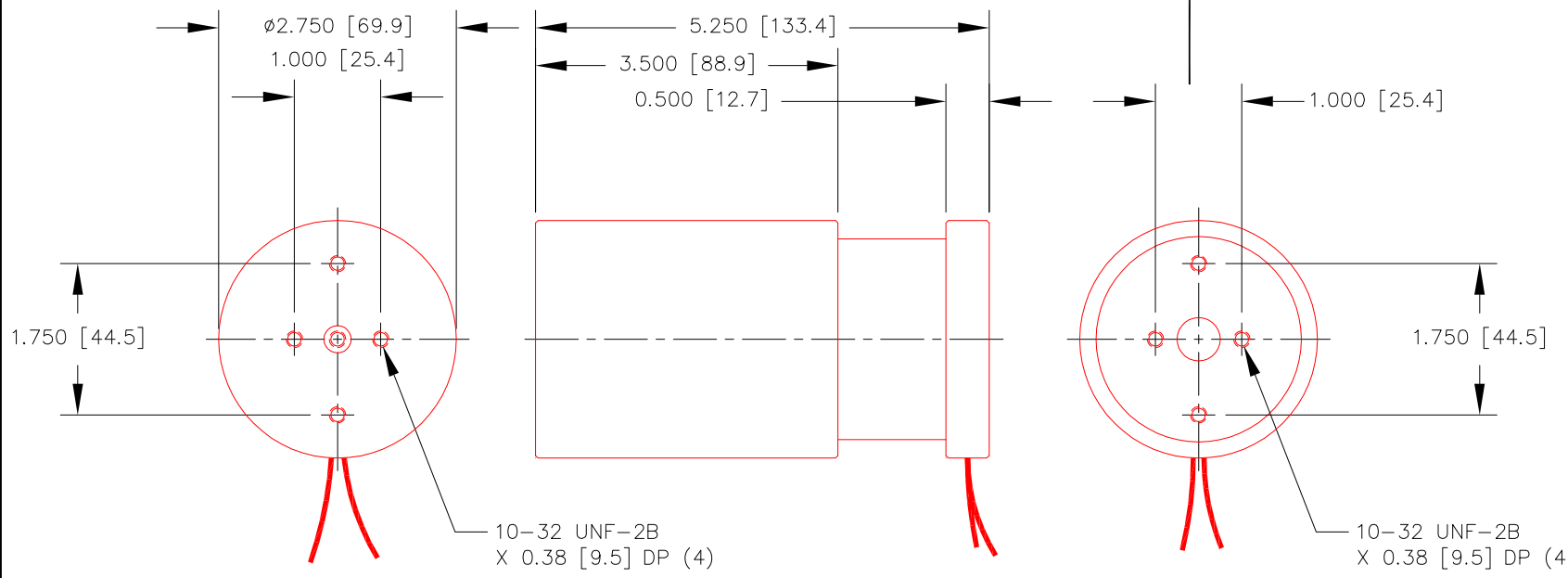

INTERMITTENT FORCE @10% DUTY CYCLE	198.3 N	44.6 LB
CONTINUOUS FORCE	62.8 N	14.1 LB
FORCE CONSTANT	11.5 N/A	2.6 LB/A
BACK EMF CONSTANT	11.5 V/M/S	0.29 V/IN/S
STROKE	63.5 mm	2.50 IN
COIL CLEARANCE PER SIDE	0.64 mm	0.025 IN
COIL ASSY MASS	410 GR	0.904 LB
BODY MASS	2.12 KG	4.67 LB
COIL RESISTANCE	2.0 Ohms	
COIL INDUCTANCE @ 1000 Hz	1.4 mH	
MAX CONTINUOUS POWER	60 W	

ALL VALUES AT 25°C

NOTES :
UNLESS OTHERWISE SPECIFIED

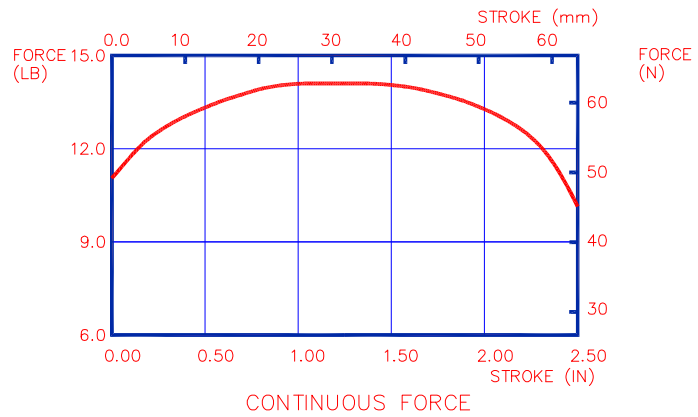

THIS DOCUMENT, WHETHER OR NOT MARKED AS PROPRIETARY, IS CONSIDERED CONFIDENTIAL AND SHALL REMAIN THE PROPERTY OF MOTICONT AND SHALL BE RETURNED TO MOTICONT UPON REQUEST WITH ALL COPIES MADE THEREOF. THIS DOCUMENT CANNOT BE UTILIZED IN THE MANUFACTURE OF ARTICLES SOLD OR OFFERED OR DISCLOSED TO ANYONE AND NO USE OF IT CAN BE MADE UNLESS EXPRESSLY AUTHORIZED BY AND UNDER THE DIRECTION OF MOTICONT. POSSESSION OF THIS DOCUMENT IS ACCEPTED SUBJECT TO THE FOREGOING.

DIMENSIONS ARE IN INCHES (mm) TOLERANCES ON: DECIMALS FRACTIONS ANGLES .XXX .XX ± 1/125 ± 1/2' ± .005 ± .01 UNLESS OTHERWISE SPECIFIED	MATERIAL	CONTRACT		motiCont LINEAR VOICE COIL MOTOR				
	FINISH	DRN						
USED ON	NEXT ASSY	CHKD			SIZE	CODE	DWG. NO.	REV.
APPLICATION		APPVD			A		LVCM-070-089-01	1
		APPVD			SCALE: 1 / 2		SHEET 1 OF 1	

B A

4 3 2 1

4

3

2

1

SHOWN AT MID-STROKE

REVISIONS

ZONE	LETTER	DESCRIPTION	DATE	CHECKED	APPROVED

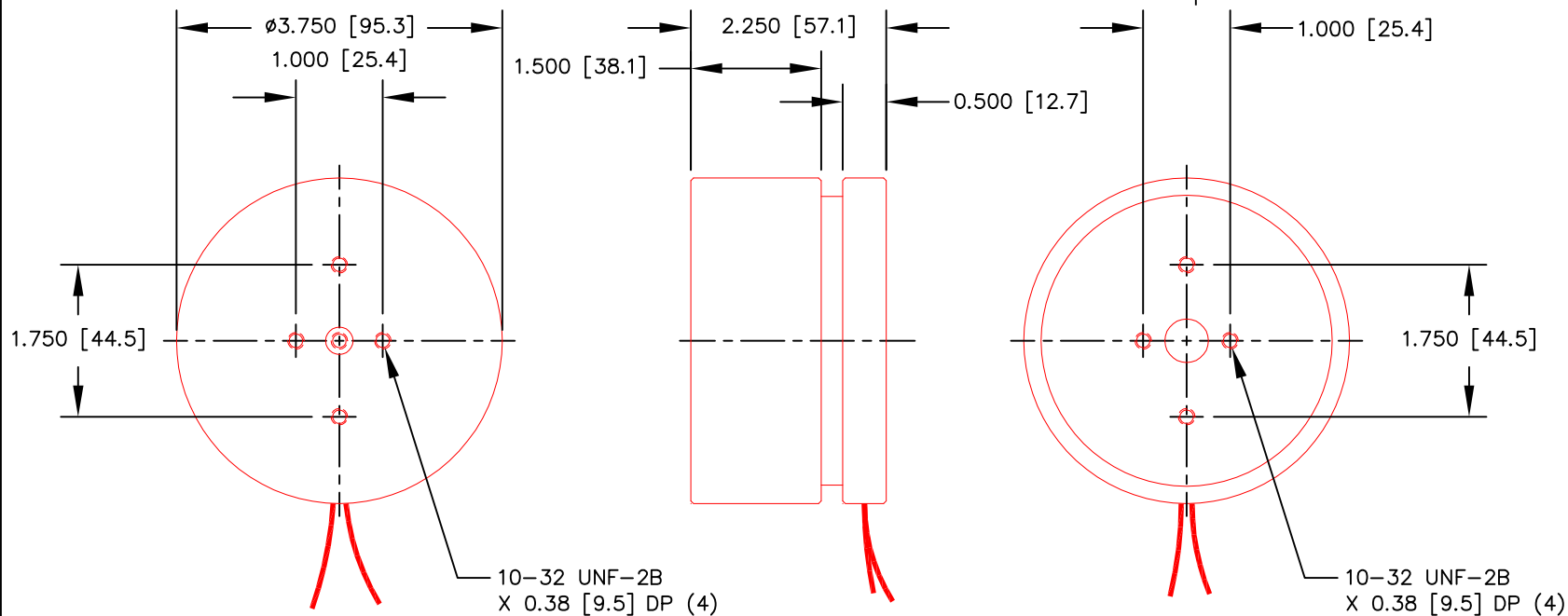

INTERMITTENT FORCE @10% DUTY CYCLE	324.4 N	73.1 LB
CONTINUOUS FORCE	102.7 N	23.1 LB
FORCE CONSTANT	38.0 N/A	8.5 LB/A
BACK EMF CONSTANT	38.0 V/M/S	0.96 V/IN/S
STROKE	12.7 mm	0.50 IN
COIL CLEARANCE PER SIDE	0.64 mm	0.025 IN
COIL ASSY MASS	326 GR	0.72 LB
BODY MASS	1.85 KG	4.07 LB
COIL RESISTANCE	6.2 Ohms	
COIL INDUCTANCE @ 1000 Hz	3.5 mH	
MAX CONTINUOUS POWER	45 W	

ALL VALUES AT 25°C

NOTES:
UNLESS OTHERWISE SPECIFIED

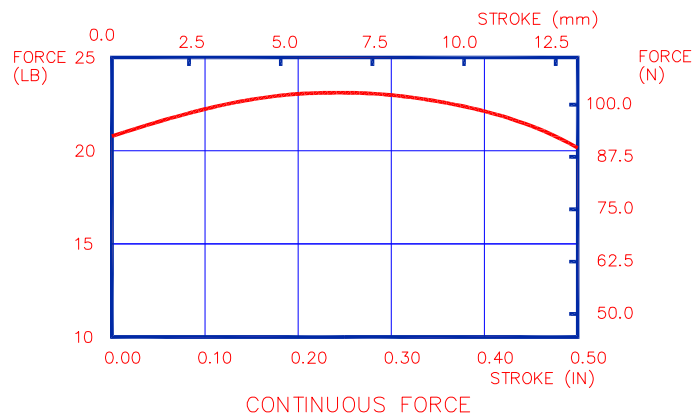

THIS DOCUMENT, WHETHER OR NOT MARKED AS PROPRIETARY, IS CONSIDERED CONFIDENTIAL AND SHALL REMAIN THE PROPERTY OF MOTICONT AND SHALL BE RETURNED TO MOTICONT UPON REQUEST WITH ALL COPIES MADE THEREOF. THIS DOCUMENT CANNOT BE UTILIZED IN THE MANUFACTURE OF ARTICLES SOLD OR OFFERED OR DISCLOSED TO ANYONE AND NO USE OF IT CAN BE MADE UNLESS EXPRESSLY AUTHORIZED BY AND UNDER THE DIRECTION OF MOTICONT. POSSESSION OF THIS DOCUMENT IS ACCEPTED SUBJECT TO THE FOREGOING.

DIMENSIONS ARE IN INCHES (mm)
TOLERANCES ON:
DECIMALS FRACTIONS ANGLES
.XXX .XX ± 1/125 ± 1/2°
± .005 ± .01
UNLESS OTHERWISE SPECIFIED

USED ON	NEXT ASSY
APPLICATION	

MATERIAL

FINISH

CONTRACT

DRN

CHKD

APPVD

APPVD

motiCont

LINEAR VOICE COIL MOTOR

SIZE

A

CODE

DWG. NO.

LVCM-095-038-01

REV.

2

SCALE: 1 / 2

SHEET 1 OF 1

4 3 2 1

REVISIONS					
ZONE	LETTER	DESCRIPTION	DATE	CHECKED	APPROVED

SHOWN AT MID-STROKE

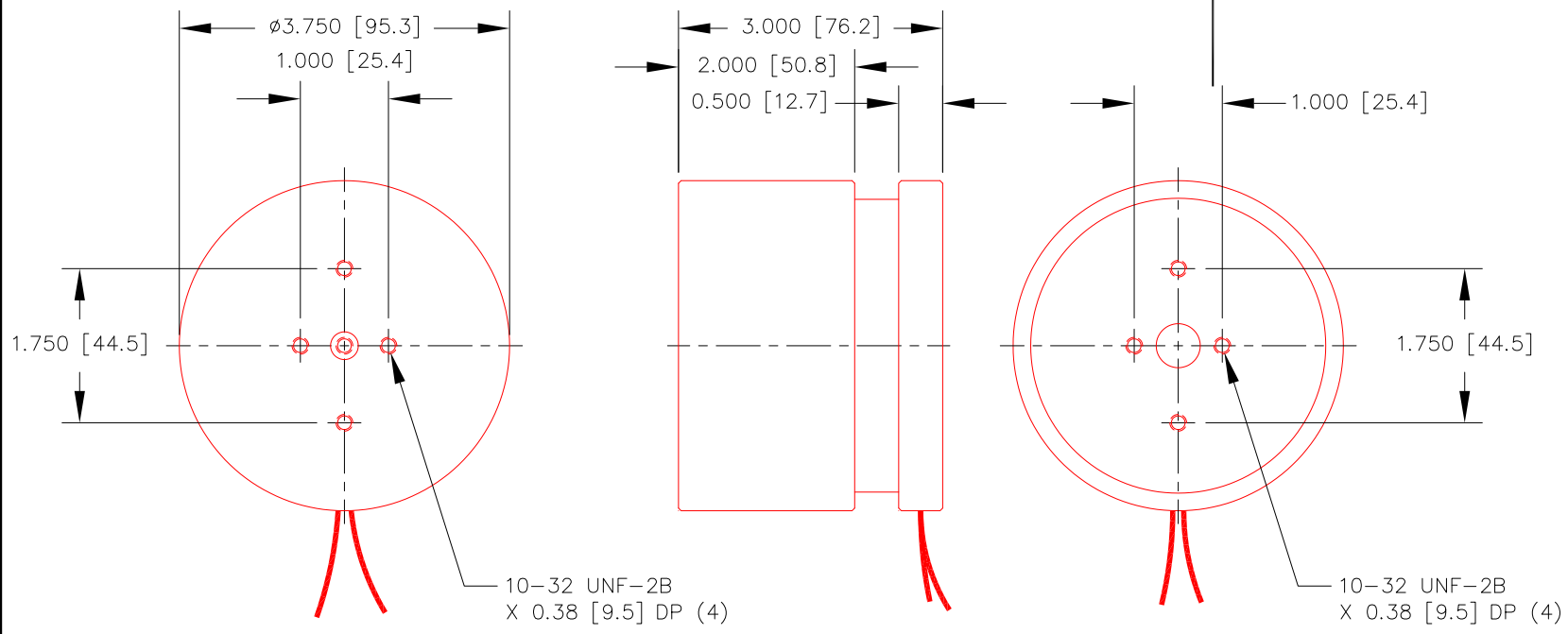

INTERMITTENT FORCE @10% DUTY CYCLE	328.7 N	74.0 LB
CONTINUOUS FORCE	104.0 N	23.5 LB
FORCE CONSTANT	44.8 N/A	10.1 LB/A
BACK EMF CONSTANT	44.8 V/M/S	1.14 V/IN/S
STROKE	25.4 mm	1.00 IN
COIL CLEARANCE PER SIDE	0.64 mm	0.025 IN
COIL ASSY MASS	395 GR	0.87 LB
BODY MASS	2.42 KG	5.34 LB
COIL RESISTANCE	9.3 Ohms	
COIL INDUCTANCE @ 1000 Hz	5.0 mH	
MAX CONTINUOUS POWER	50 W	

ALL VALUES AT 25°C

NOTES :
UNLESS OTHERWISE SPECIFIED

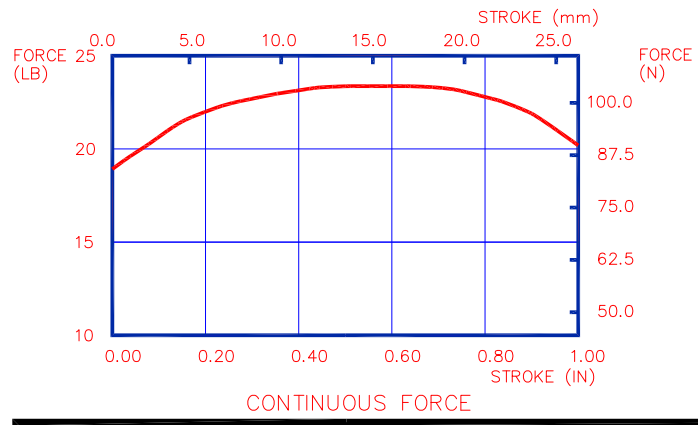

THIS DOCUMENT, WHETHER OR NOT MARKED AS PROPRIETARY, IS CONSIDERED CONFIDENTIAL AND SHALL REMAIN THE PROPERTY OF MOTICONT AND SHALL BE RETURNED TO MOTICONT UPON REQUEST WITH ALL COPIES MADE THEREOF. THIS DOCUMENT CANNOT BE UTILIZED IN THE MANUFACTURE OF ARTICLES SOLD OR OFFERED OR DISCLOSED TO ANYONE AND NO USE OF IT CAN BE MADE UNLESS EXPRESSLY AUTHORIZED BY AND UNDER THE DIRECTION OF MOTICONT. POSSESSION OF THIS DOCUMENT IS ACCEPTED SUBJECT TO THE FOREGOING.

DIMENSIONS ARE IN INCHES (mm) TOLERANCES ON: DECIMALS FRACTIONS ANGLES .XXX .XX ± 1/125 ± 1/2" ± .005 ± .01 UNLESS OTHERWISE SPECIFIED		MATERIAL	CONTRACT							
FINISH		DRN						LINEAR VOICE COIL MOTOR		
USED ON		NEXT ASSY		CHKD			SIZE	CODE	DWG. NO.	REV.
APPLICATION				APPVD			Δ		LVCM-095-051-01	1
				APPVD			SCALE: 1 / 2		SHEET 1 OF 1	

D
C
B
A

D
C
B
A

4 3 2 1

4 3 2 1

REVISIONS					
ZONE	LETTER	DESCRIPTION	DATE	CHECKED	APPROVED

SHOWN AT MID-STROKE

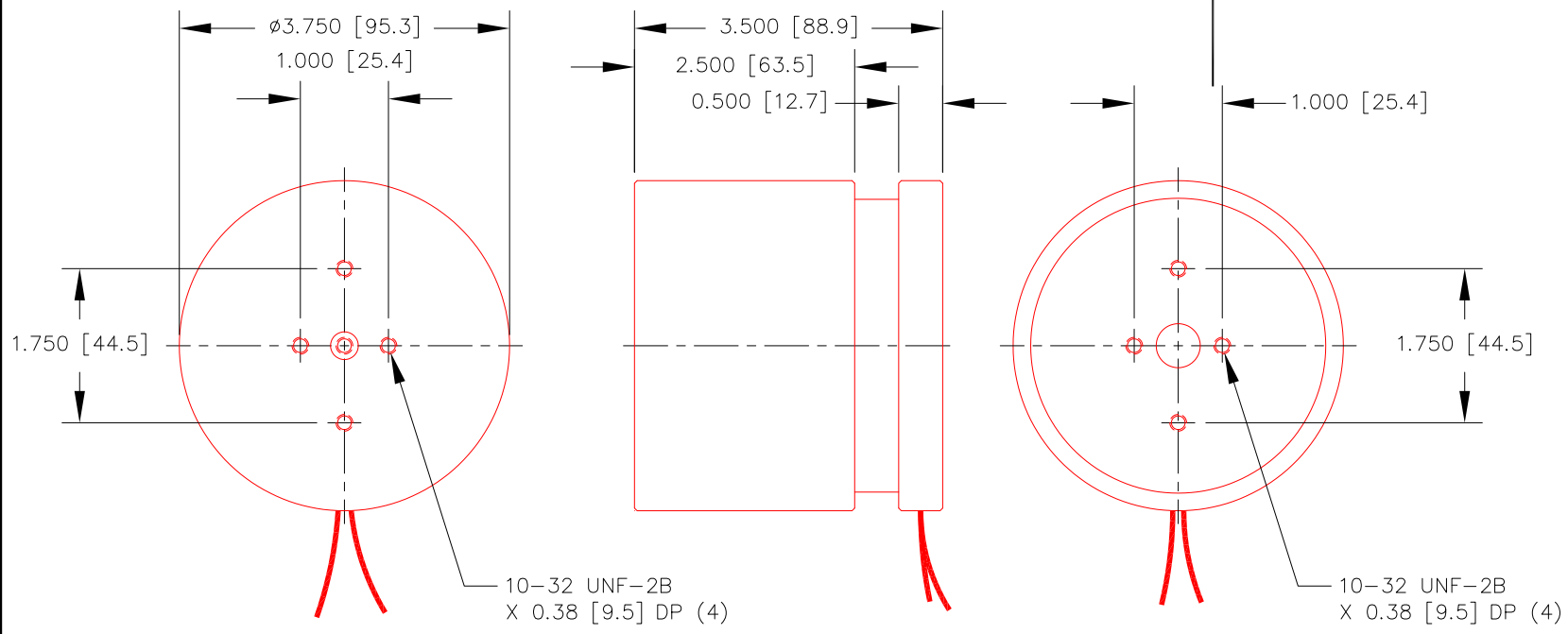

INTERMITTENT FORCE @10% DUTY CYCLE	342.0 N	77.1 LB
CONTINUOUS FORCE	108.2 N	24.4 LB
FORCE CONSTANT	21.1 N/A	4.8 LB/A
BACK EMF CONSTANT	21.1 V/M/S	0.54 V/IN/S
STROKE	38.1 mm	1.50 IN
COIL CLEARANCE PER SIDE	0.64 mm	0.025 IN
COIL ASSY MASS	484 GR	1.07 LB
BODY MASS	3.00 KG	6.61 LB
COIL RESISTANCE	2.1 Ohms	
COIL INDUCTANCE @ 1000 Hz	1.2 mH	
MAX CONTINUOUS POWER	55 W	

ALL VALUES AT 25°C

NOTES :
UNLESS OTHERWISE SPECIFIED

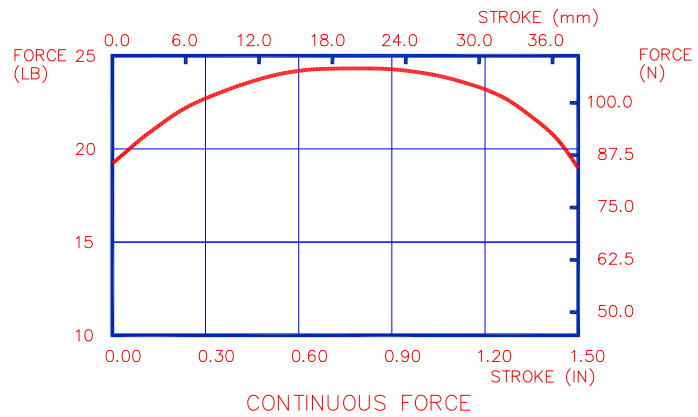

THIS DOCUMENT, WHETHER OR NOT MARKED AS PROPRIETARY, IS CONSIDERED CONFIDENTIAL AND SHALL REMAIN THE PROPERTY OF MOTICONT AND SHALL BE RETURNED TO MOTICONT UPON REQUEST WITH ALL COPIES MADE THEREOF. THIS DOCUMENT CANNOT BE UTILIZED IN THE MANUFACTURE OF ARTICLES SOLD OR OFFERED OR DISCLOSED TO ANYONE AND NO USE OF IT CAN BE MADE UNLESS EXPRESSLY AUTHORIZED BY AND UNDER THE DIRECTION OF MOTICONT. POSSESSION OF THIS DOCUMENT IS ACCEPTED SUBJECT TO THE FOREGOING.

DIMENSIONS ARE IN INCHES (mm) TOLERANCES ON: DECIMALS FRACTIONS ANGLES .XXX .XX ± 1/125 ± 1/2" ± .005 ± .01 UNLESS OTHERWISE SPECIFIED		MATERIAL	CONTRACT		motiCont LINEAR VOICE COIL MOTOR	
FINISH		DRN				
USED ON		CHKD			SIZE	CODE
NEXT ASSY		APPVD			DWG. NO.	
APPLICATION		APPVD			LVCM-095-064-01	
					REV.	
					1	
					SCALE: 1 / 2 SHEET 1 OF 1	

4

3

2

1

SHOWN AT MID-STROKE

REVISIONS

ZONE	LETTER	DESCRIPTION	DATE	CHECKED	APPROVED

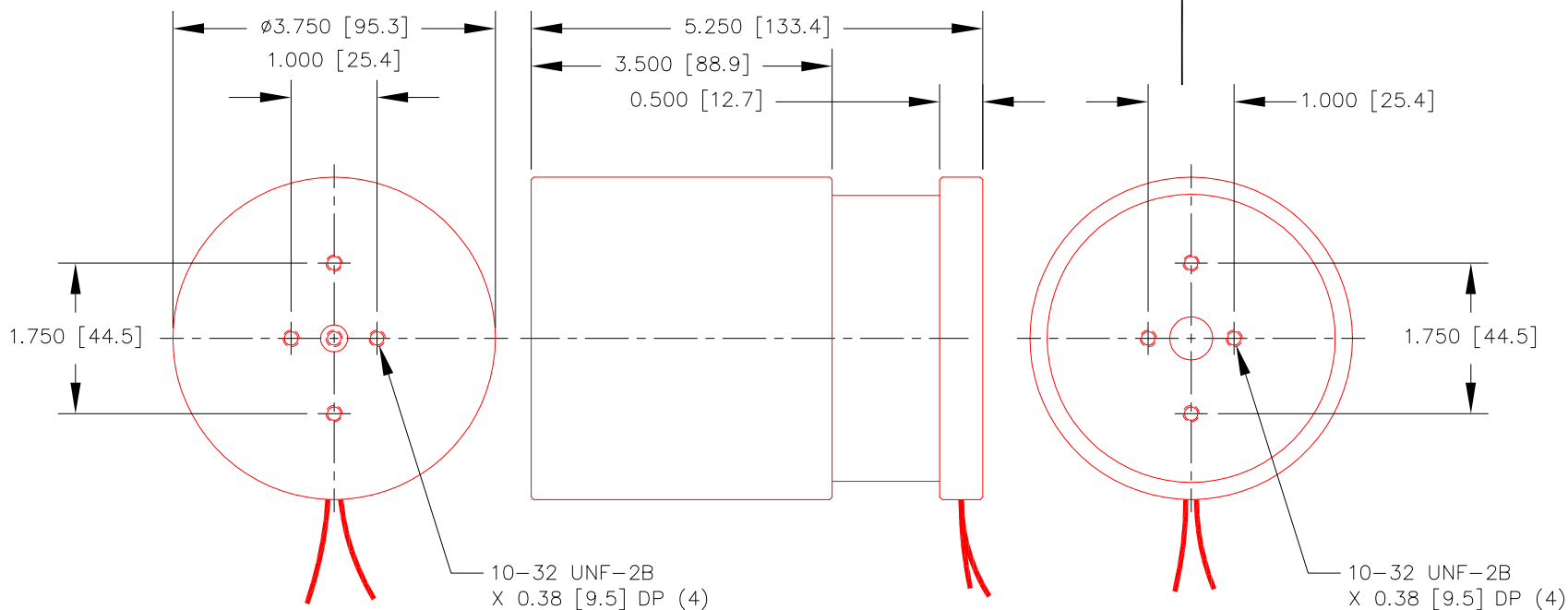

INTERMITTENT FORCE @10% DUTY CYCLE	351.3 N	79.0 LB
CONTINUOUS FORCE	111.2 N	25.0 LB
FORCE CONSTANT	22.2 N/A	5.0 LB/A
BACK EMF CONSTANT	22.2 V/M/S	0.57 V/IN/S
STROKE	63.5 mm	2.50 IN
COIL CLEARANCE PER SIDE	0.64 mm	0.025 IN
COIL ASSY MASS	632 GR	1.39 LB
BODY MASS	4.14 KG	9.14 LB
COIL RESISTANCE	3.0 Ohms	
COIL INDUCTANCE @ 1000 Hz	2.1 mH	
MAX CONTINUOUS POWER	75 W	

ALL VALUES AT 25°C

NOTES :
UNLESS OTHERWISE SPECIFIED

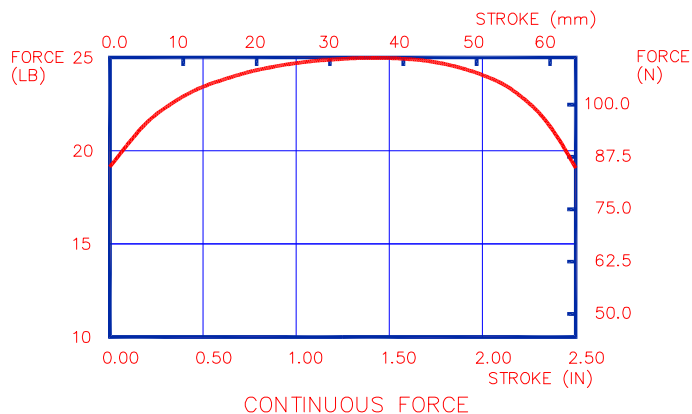

THIS DOCUMENT, WHETHER OR NOT MARKED AS PROPRIETARY, IS CONSIDERED CONFIDENTIAL AND SHALL REMAIN THE PROPERTY OF MOTICONT AND SHALL BE RETURNED TO MOTICONT UPON REQUEST WITH ALL COPIES MADE THEREOF. THIS DOCUMENT CANNOT BE UTILIZED IN THE MANUFACTURE OF ARTICLES SOLD OR OFFERED OR DISCLOSED TO ANYONE AND NO USE OF IT CAN BE MADE UNLESS EXPRESSLY AUTHORIZED BY AND UNDER THE DIRECTION OF MOTICONT. POSSESSION OF THIS DOCUMENT IS ACCEPTED SUBJECT TO THE FOREGOING.

DIMENSIONS ARE IN INCHES (mm)
TOLERANCES ON:
DECIMALS FRACTIONS ANGLES
.XXX .XX ± 1/125 ± 1/2'
± .005 ± .01
UNLESS OTHERWISE SPECIFIED

MATERIAL

CONTRACT

motiCont

USED ON	NEXT ASSY
APPLICATION	

FINISH

DRN

CHKD

APPVD

APPVD

LINEAR VOICE COIL MOTOR

SIZE
A

CODE

DWG. NO.

LVCM-095-089-01

REV.

1

SCALE: 1 / 2

SHEET 1 OF 1